

ExCam[®] miniTube

User Manual



SAMCON

Prozessleittechnik GmbH

Content

1	Introduction	4
2	Technical Data	4
2.1	Parameters of the explosion protection	4
2.2	Illustration of the model key.....	5
2.3	Electrical parameters.....	6
2.4	System cable.....	6
2.5	Technical specification of the camera module.....	6
2.6	Other technical data	7
3	Safety guidelines	9
4	Commissioning	10
4.1	Step 1: Installation.....	10
4.2	Step 2: Electrical connection	10
4.2.1	Potential equalization.....	11
4.2.2	Connection and protection.....	12
4.2.2.1	Power supply & protection of the camera circuit	13
4.2.2.2	Video picture connection (CVBS or AHD)	14
4.2.3	Tests prior to switching on voltage	14
5	Video converter (optional accessory).....	15
6	Maintenance / Servicing / Alterations	16
7	Repairs and Maintenance	16
8	Disposal / Recycling	16
9	Drawings	17
10	Certificates and further documentation.....	17
11	Notes.....	18

Table of Figures

Table 2.1 – Model key	5
Figure 4.1 – PE connection ExCam miniTube	11
Table 4.1 – Potential equalization.....	11
Figure 4.2 – Ex d cable gland with cable (figure similar)	12
Figure 4.3 – ExCam miniTube T08-VA0.1.K1.BOR-N.N-xxx.N- P	12
Figure 4.4 – ExCam miniTube T08-VA0.1.K1.BOR-N.N-xxx.N- K	12
Table 4.2 – Electrical connection camera module	13
Table 4.3 – Supply protection camera module	13
Table 4.6 – Terminal block connection CVBS signal	14
Table 4.7 – Plug connection CVBS signal	14
Figure.5.1 – Setting of the DIP Switch Videoconverter	15
Figure.5.2 –Signal-output-variants.....	15
Figure.5.3 – Panel-View	15
Figure 9.1 – Dimensions of the T08 ExCam miniTube	17

Revision history

Product: ExCam® miniTube
 Title: User manual ExCam® miniTube Typ 08
 Doc. -Id. 200618-PT08BA-ES-ExCam miniTube_en_rev.02.docx
 Author: Eva Schneider
 Date: June 18, 2020
 Latest update: 10.06.2022

Rev.- Index	Date	Name	Remarks	Authorization of the EX Supervisor
0	June 18, 2020	E. Schneider	Compilation of the document	
1	27.10. 2021	E. Schneider	Change of the camera module	
2	10.06.2022	E.Schneider	Optional Lenses	

1 Introduction



The ExCam miniTube is an ultra compact and robust analog camera (type T08) which is manufactured by SAMCON Prozessleittechnik GmbH and can be used very flexibly for various applications. The main application is the usage within the hazardous areas of the chemical and/or petro-chemical industry, at offshore plants, and at biogas plants. The ExCam® miniTube is a static camera system with a fixed lens.

The camera is suitable for the usage within the Ex zones 1, 2, 21, and 22 including the gas group IIC (all gases, steams, and fogs including acetylene, hydrogen, and carbon disulphide) and the dust group IIIC (conductive dusts and flammable fibrous material). Besides for fixed installation, the T08 ExCam series is also certified to be used for mobile applications (hand-held etc. DIN EN 60079: 0 2012). Due to the usage of high-quality PTFE sealings, not only the protection level IP68 is met but also the chemical resistance is maximized.

2 Technical Data

2.1 Parameters of the explosion protection

Identification marks according to Directive RL 2014/34/EU:

 II 2G (Zone 1 and 2)
 II 2D (Zone 21 and 22)

Explosion protection (gas):
 Explosion protection (dust):

Ex db IIC T6 Gb
 Ex tb IIIC T80°C Db

Protection level:

IP 66/68 (IEC/ EN 60529)
 (0.5h/ 8m water column)

Transportation / storage temperature:
 Ambient temperature (EX):

0°C ... +50°C
 -10°C ... +50°C

Noticed body:
 EU Type Examination:
 IECEx certificate:
 Further certificates:

TÜV Rheinland (number 0035)
 TÜV 18 ATEX 8218 X (2020)
 IECEx TUR 18.0023X (2020)
 see: <https://www.samcon.eu/en/products/analog/excam-minitube/>



Attention!

The instructions stated on the type and instruction plates have to be observed!

2.2 Illustration of the model key

Ex product name	Model versions					Option
1)	2) Type	3) Housing- combination	4) Temp.- range	5) Cable length [m]	6) Termi- nation	7) Lens
ExCam miniTube	T08-	VA0.1.K1.BOR-	N.N-	005.N-	P-	080/056/041
	T08-	VA0.1.K1.BOR-	N.N-	005.N-	K-	080/056/041

Table 2.1 – Model key

Explanations:

- 1) ExCam miniTube = Functional camera description of the ExCam Series (technical data / specification of the individual camera module)
- 2) **T08** = SAMCON Production type 08
- 3) **VA0.1.K1.BOR** = T07 Ex d housing (stainless steel 1.4404) with small diameter ($\varnothing_{VA}=48\text{mm}$)
VA0.1.K1.BOR = T07 VA0.x housing with maximum body length ($L_{VA0,1,R} = 127\text{mm}$)
VA0.1.K1.BOR = K1 cable gland flange (axial cable gland, standard)
VA0.1.K1.BOR = Borosilicate sight glass DIN7080 standard execution, for video cameras within visible spectral range and photographic infrared range (NIR), not suitable for thermographic applications (MIR/ FIR)
- 4) **N.N** = Normal ambient temperature range, no heater installed ($T_{amb} > -10^{\circ}\text{C}$)
N.N= No cooling system installed ($T_{amb} < +50^{\circ}\text{C}$)
- 5) **005.N** = Length of the connection line in meter at delivery. The standard cable length is 5 m, minimum / maximum cable length is: 005...250 [m]
005.N = Non armoured cable
- 6) **P** = Plug- termination (standard): cable stripped ca. 30 cm with anti-kink grommet, 4x single wire 0.75mm² with wire end ferrules (grey) and 1x double wire (Koax) on BNC angle plug AWG24 crimped
- K** = Terminal block execution (optional): Approx. 30 cm of the system cable is stripped and equipped with tension reliefs, 6x single conductors with ferrules
- 7) **Lens Options**

Model	Lens	Iris	Horizontal AoV @ 16/9
T08-VA0.1.K1.BOR-X.X-XXX-X-080 (Standard)	Megapixel Objektiv 3.6mm	F3.6	80°
T08-VA0.1.K1.BOR-X.X-XXX-X-056	Megapixel Objektiv 6.0mm	F1.9	56°
T08-VA0.1.K1.BOR-X.X-XXX-X-041	Megapixel Objektiv 8.0mm	F1.8	41°

2.3 Electrical parameters

Power supply camera: 12VDC \pm 0.3 V DC

2.4 System cable

Outer diameter: 9.4 \pm 0.3mm
Bending radius: >12 x outer diameter
Temperature range: -20°C to +80°C (at point of installation)
-40°C to +80°C (fixed installed)
Conductor design: Koax 75OHM 2x2x0,25mm² +4x0,75mm² AWG24
Shielding: Copper braid, multiple wires 0.10 vz, opt. coverage approx. 90%
Outer sheath/characteristics: PUR FHF, halogen free, flame resistant (EN 60332-1-2), EMV shielded



Attention!

For wiring and connection of the camera, DIN/EN/IEC 60079-14 has to be observed.

2.5 Technical specification of the camera module

Please note:

Technical details of the internal module such as light sensitivity, resolution, frame rate sensor, lens details and optional accessories are thoroughly provided in the data sheets on our homepage and are not part of the T08 ExCam user manual.

Data sheets:

<https://www.samcon.eu/en/products/analog/excam-minitube/>



2.6 Other technical data

Housing material of the pressure resistant enclosure (Ex d / DIN EN 60079-1: 2014) according to **DIN EN 10027-2: 2015-07** (designation system for steel):

Housing material (standard)

MNo.: 1.4404 (X2CrNiMo17-12-2),
AISI 316L / V4A

Additional metallic and non-metallic materials of the T07-VA1.2.x.x ex-d housing:

Zincd spring steel MNo.: 1.0330, PTFE with glass microbeads (GYLON® Style 3504 blue), silicone-coating (Momentive), thermos transfer foil made of polyester (acetone resistant), cable glands made of brass, nickel-plated (MsNi)

Sight glass material:

Borosilicate glass "Ilmadur 10/ I-420"
 (DIN7080¹:2005-05)

Internal materials:

Optical and electronical components, div. thermoplastic plastics: polyamide (PA6.6/ PA2000) and polyoxymethylene (POM) isolators and supporting adapters, aluminum die cast, zincd (protection housing T08 aluminum universal adapter (EN AW-ALSi1MgMn), PUR, etc.

Weight (without accessories):

600 g (with K1 cable flange

Weight of accessories:

800 g (wall mount bracket WMB-VA1.x)

50 g (hinge attachment SCH-VA1.x)

(further accessories upon request)

Dimensions housing (wxhxd):

48.0mm x 48.0mm x 127.0mm

Dimensions with accessories (WxHxD):

97.0mm x 193.0mm x 299.5mm

(with wall mount bracket and hood)

Fitting of the flame proof gap preventing the transmission of ignition (cylinder) (EX) of the T07-VA0.1.x.x housing:

Flange / body

Nominal diameter: **35 mm** (plain cylindrical)

Clearance fit: **H8 f7** (DIN ISO 286)

Tolerance: (-50...-25) µm ... (0...+39) µm

Smallest gap length > 12.5 mm

(according to DIN EN 60079-1)

Largest gap length < 0.15 mm

¹ Valid standards for translucent components in a pressure-tight housing: DIN7080:2005-05 „Round sight glasses made of borosilicate glass for compressive stress without limitation of the low temperature ranges“

(according to DIN EN 60079-1)

Average surface finish: $R_a \approx 2.0 \mu\text{m}$

(DIN ISO 468) / $R_a \leq 6.3 \mu\text{m}$

(according to DIN EN 60079-1: 2018 [5.2.2])

Cable glands

1x **M20*1.5**_12 mm (ISO metrical fine thread acc. to DIN13-2), **Quality 6H** (medium or fine (acc. to. ISO 965-1 / ISO 965-3), supporting/**gripping threads ≥ 5** (acc. to the requirements of DIN EN 60079-1: 2014 [5.3] table 3 „cylindrical threads“)

Media resistance:

Exclusively checked upon request!

Generally: Corrosion as well as chemical highly resistant against a variety of fluid and gaseous components of the industrial area and suitable for offshore applications (see general specification of stainless steel MNo.:1.4404 / AISI316L), surface finish and modification of the Ex d housing², elastomer sealings of the cables, as well as the GYLON® flat seals of the housing flange, etc.)

² Protective coating, electro polishing, etc. ...

3 Safety guidelines

Please observe the national regulations regarding security and accident prevention and the safety guidelines given below in this user manual!



Attention!

Cameras of the type ExCam T08 Series are not suitable for the use in zone 0 and zone 20. The temperature class and explosion group as stated on the type plate has to be observed. Alterations are not permitted. The camera is to be operated in sound conditions and in the intended way.



Attention!

Only original parts of SAMCON Prozessleittechnik GmbH may be used for repairs. Repairs concerning the explosion protection may only be carried out in accordance with the nationally applied regulations and by SAMCON Prozessleittechnik GmbH.



Attention!

External heat and/ or cooling sources are to be taken into account during the setting up. The permissible temperature range for transportation, storage, and operation of the camera has to be observed



Attention!

The instructions stated on the type and instruction plates have to be observed:

**„WARNING - DO NOT OPEN IN POTENTIALLY EXPLOSIVE
ATMOSPHERES “**



The use in hazardous areas with regard to temperature and dust layers is defined in the respective national regulations.

Prior to the first use, you should test the camera corresponding to the instructions given in the chapter commissioning.

4 Commissioning

For the camera's installation and operation, the relevant national regulations, as well as the generally accepted rules of technology shall prevail. Before mounting the camera, thoroughly check it for any transportation damages, especially at the housing and cable. Installation, electrical connection, and the first commissioning must only be carried out by qualified personnel.



Attention!

Please observe the national regulations regarding security, installation, and accident prevention (e.g. DIN EN 60079-14) and the safety guidelines described in the user and in the EX installation manual!



Attention!

Please observe the installation and commissioning advices described in the ATEX/ IECEx Ex-installation manual!

4.1 Step 1: Installation

Install the ExCam[®] miniTube at the desired location. Mounting options and conditions, accessories, as well as safety guidelines are described in the EX installation manual of the T08 ExCam[®] Series.



Attention!

Prior to the camera installation, take external sources of heat or cold into account! Observe the permissible temperature range!

4.2 Step 2: Electrical connection



Attention!

The electrical connection of the equipment must be executed by qualified personnel only!



Attention!

It is mandatory that the housing of the ExCam[®] Series has to be grounded via a PE-connection!



Attention!

Please observe the national regulations regarding security, installation, and accident prevention (e.g. DIN EN 60079-14), as well as the safety guidelines described in this user manual and the EX installation manual!

The T08 ExCam® miniTube is delivered with an electrical connection. The maximum transmission distance from camera to receiver typically is 250 m (depending on electromagnetic tolerance/ EMC environment) and can be determined individually to reflect the particular customer specifications.

The ExCam® miniTube is manufactured with a cable pigtail reflecting the desired cable length. Any electro-technical work inside the camera's flameproof enclosure which is done by the user is prohibited and not required. Depending on the model option, the ending of the camera's cable connection is either furnished with a plug or terminal block excusion.

4.2.1 Potential equalization

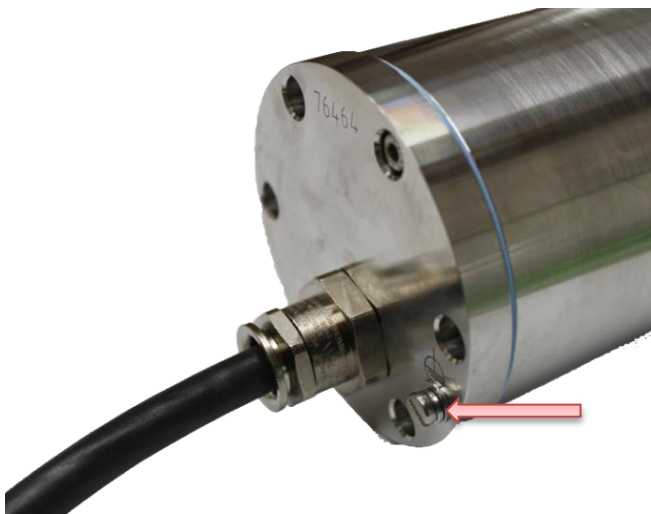

Figure 4.1 – PE connection ExCam miniTube

The potential equalization (earthing of the camera housing) is mandatory in order to avoid electrostatic charging and hence spark generation. The screw terminal on the housing's rear side is intended for this purpose (q.v. figure 4.1). The profile of the potential equalization has to reflect the national grounding instructions (min. 4 mm²).

Connection table:

Potential	Color (IEC 60757)	Profile	Comment
PE	GN/YE	4 mm ² (fix)	Screw terminal: Slotted screw M3 x 0.5 (DIN 84) with washer Ø 9 mm (DIN 125A). 1.2Nm tightening torque has to be observed!

Table 4.1 – Potential equalization

4.2.2 Connection and protection

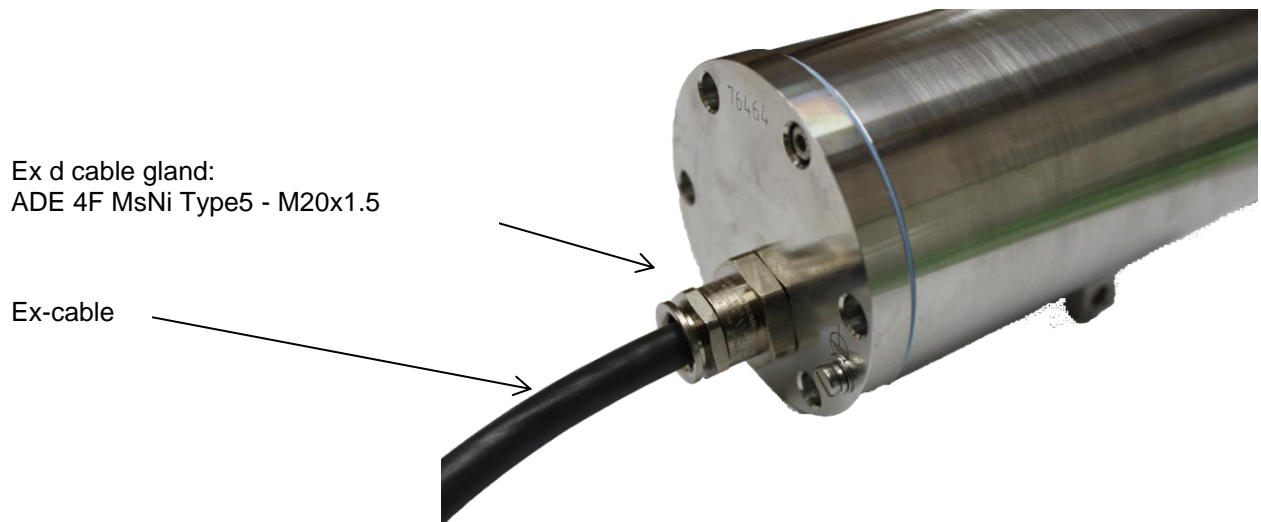

Figure 4.2 – Ex d cable gland with cable (figure similar)

Figures 4.3 and 4.4 illustrate the possible cable terminations available for the ExCam miniTube.

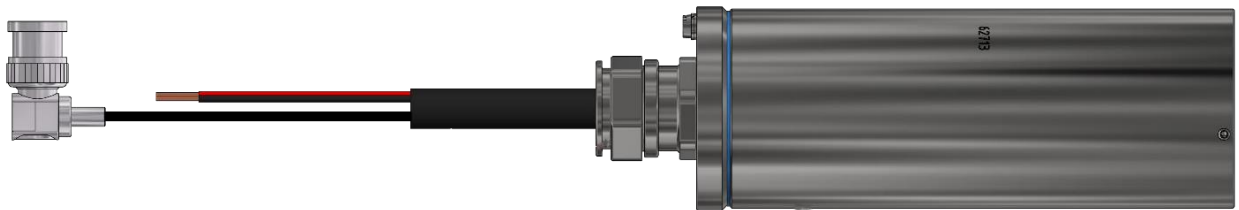

Figure 4.3 – ExCam miniTube T08-VA0.1.K1.BOR-N.N-xxx.N-**P**

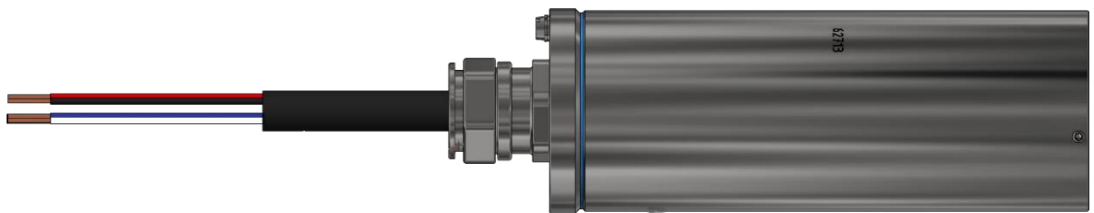

Figure 4.4 – ExCam miniTube T08-VA0.1.K1.BOR-N.N-xxx.N-**K**

Via the system cable the AHD or CVBS signal is transferred. The power supply of the camera and the optional heating mode is also conducted via this cable.

4.2.2.1 Power supply & protection of the camera circuit



Attention!
Cables and wires must comply with the requirements of the IEC 60079-0/1/7 & 14.



Attention!
The supply line must have a sufficient cross-section. The cable protection must comply with national and international regulations.



Attention!
Use only terminals approved by SAMCON.

The power supply has to be done via the red (RD) as well as the black (BK) connection strand.

Connection table:

Potential	Color (IEC 60757)	Potential level	Profile	Remarks
L+	RD	+12 V DC	0.75 mm ²	
L-	BK	0 V DC / GND	0.75 mm ²	

Table 4.2 – Electrical connection camera module

The camera's typical power consumption is 1.2 Watt.

The dimensioning of the equipment or the supply protection depends on:

- The selected power supply
- The cable length
- The national regulations

The following safety recommendations may serve as a basis:

Supplied power	Length system cable	Recommended protection	Comments
12.3 V DC	< 100 m	500 mA - mT	In case the transmission range exceeds 100 m and it is intended to supply the camera with 12.3 V DC, please make sure to use an adjustable power supply in order to compensate voltage drops
13 V DC	100 m - 250 m	500 mA - mT	In case the transmission range exceeds 100 m and it is intended to supply the camera with 13 V DC, please make sure to use an adjustable power supply in order to compensate voltage drops

Table 4.3 – Supply protection camera module

The release current of the protection has to be less than the maximum short-circuit current of the power supply (switch-mode power supply)!

4.2.2.2 Video picture connection (CVBS or AHD)

Depending on the model key, the video signal of the ExCam® miniTube is either provided with wire-end (K-option) or with a BNC connector (P-option). The video signal is only to be connected to a monitor, a video matrix, or a video server.

The video output is always 16:9. For systems with a resolution at 4:3, a video converter (see chapter 5) is needed.

Connection table (T08-VA0.1.K1.BOR-N.N-xxx.N-K)

Potential	Color (IEC 60757)	Potential level	Profile	Comments
CVBS+	WH/ BU	1.0 V _{p-p} (sync negative)	0.5 mm ²	
CVBS _GND	BU	0 V / GND	2.7 mm ²	

Table 4.6 – Terminal block connection CVBS signal

Connection table (T08-VA0.1.K1.BOR-N.N-xxx.N-P)

Potential	BNC connector	Potential level	Profile	Comments
CVBS +	Center (Pin) / core	1.0 V _{p-p} (sync negative)		AWG24
CVBS _GND	Shield (bayonet cap)	0 V / GND		

Table 4.7 – Plug connection CVBS signal

4.2.3 Tests prior to switching on voltage



Attention!

Prior to commissioning, all tests as indicated by the national regulations have to be executed. In addition, it is mandatory that the proper functioning of the operating device in accordance with this user manual and all other applicable regulation has been executed.



Attention!

Incorrect installation and operation of the camera may lead to a loss of warranty!



Attention!

Do not switch on the camera at temperatures below 0°C!

5 Video converter (optional accessory)

To switch the image format from 16:9 to 4:3 the video converter is needed. It is an optional accessory and not included.



Figure.5.1 – Setting of the DIP Switch Videoconverter

To configure the Underscan, the arrow buttons have to be pressed: The left arrow minimizes the Underscan, the right arrow increases it. Maximum Underscan is up to 20%. By pressing both arrow buttons at the same time, the format can be selected 16:9 or 4:3. 3 possible signal-output-options (HDMI, VGA, CVBS) can be displayed at the same time.

CVBS Output Mode:

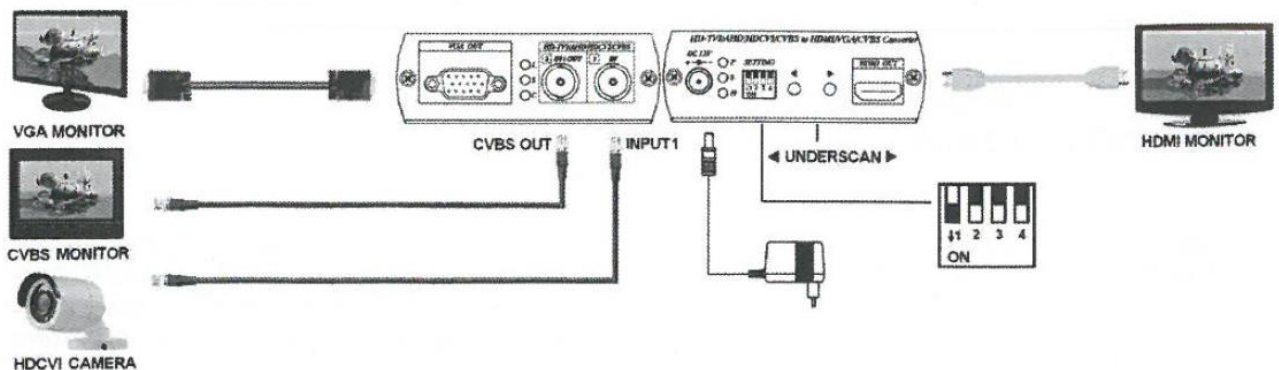
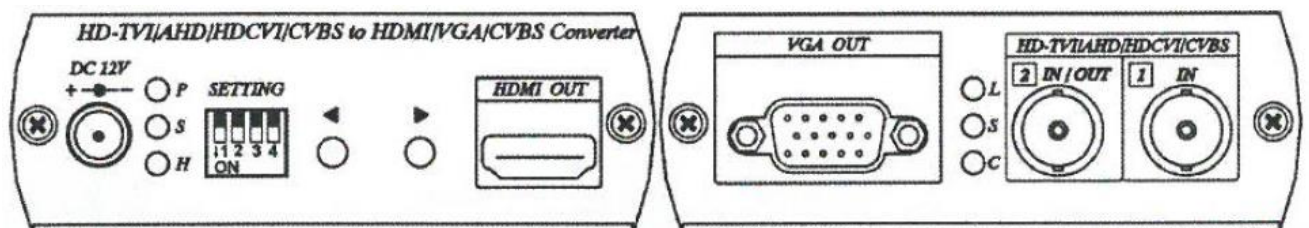

Figure.5.2 –Signal-output-variants



DC 12 V 12 V DC power supply
 HDMI OUT HDMI Out-connection
 VGA OUT VGA Out-connection
 1 IN Camera Input (AHD IN 16:9)
 2 IN/OUT Camera Output (CVBS OUT 4:3)

Figure.5.3 – Panel-View

6 Maintenance / Servicing / Alterations

The national regulations concerning the maintenance and servicing of electrical devices within hazardous areas are to be observed.

The required maintenance intervals are specific to the individual devices. The operating company has to determine these intervals depending on the application parameters. During maintenance, focus has to be put on checking parts concerning the ignition protection category such as the integrity of the housing, the sealings and the cable glands. If maintenance measures are necessary they have to be initiated and/or executed.

7 Repairs and Maintenance

Repairs must only be carried out with original parts of SAMCON Prozessleittechnik GmbH. Damaged pressure-resistant housings have to be replaced completely. If in doubt, return the applicable part to SAMCON Prozessleittechnik GmbH.

Repairs concerning the explosion protection must only be carried out by SAMCON Prozessleittechnik GmbH or a qualified electrical technician authorized by SAMCON Prozessleittechnik GmbH in accordance with nationally applied regulations. Rebuilding of or alterations to the devices are not permitted.

8 Disposal / Recycling

When disposing of the device, nationally applicable regulations must be observed.

This document is subject to alterations and additions.

9 Drawings

The drawings below are technical drawings of the T08 ExCam miniTube.

Further drawings also for additional accessories, 3D models, STEP files and DXF shapes are available on the SAMCON homepage:

<https://www.samcon.eu/en/products/analog/excam-minitube/>

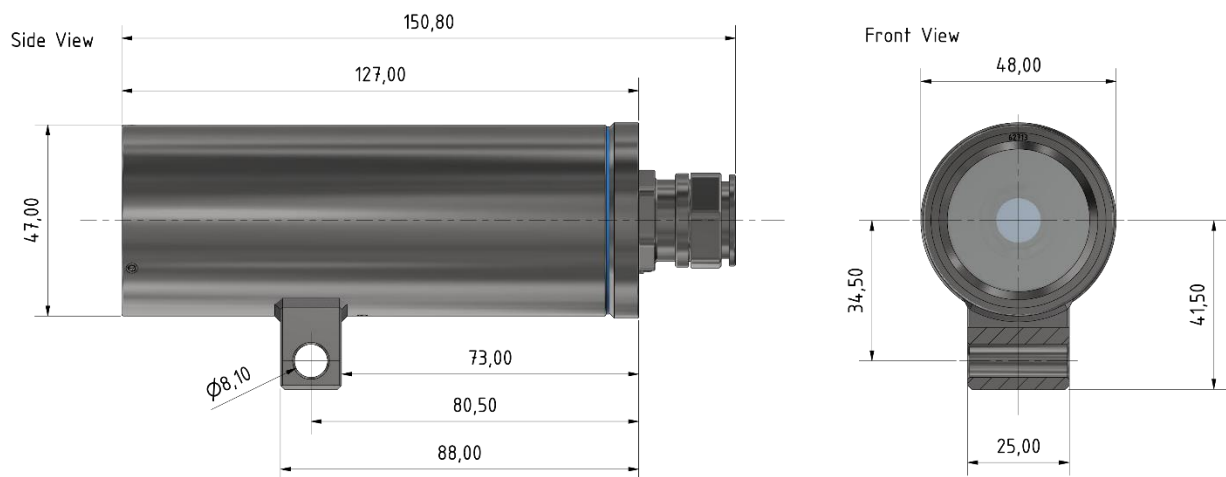

Figure 9.1 – Dimensions of the T08 ExCam miniTube

10 Certificates and further documentation

Certificates and further technical documents can be found on our homepage:

<https://www.samcon.eu/en/products/analog/excam-minitube/>

11 Notes



SAMCON

Schillerstrasse 17, 35102 Lohra-Altenvers
www.samcon.eu, info@samcon.eu
fon: +49 6426 9231-0, fax: - 31

