

ExCam[®] IPP1377

User Manual



Table of contents

1	Introduction	5
2	Technical data	5
2.1	Explosion protection	5
2.2	Illustration of the model key.....	6
2.3	Electrical parameters of the camera.....	7
2.4	Connection cable Ex-d - Ex-e.....	7
2.4.1	Connection cable for models without heater (SKD02-T/ASKD02-T).....	7
2.4.2	Connection cable for models with heater (SKDP03-T/ASKDP03-T).....	8
2.5	Video-technical characteristics.....	9
2.6	Other technical data	9
3	Safety Instructions	10
4	Installation	11
5	Electrical connection	13
5.1	Potential equalization	13
5.2	Connection and Fusing	14
5.3	Example: external connection and fusing via the terminal box.....	20
5.3.1	Example: direct routing from the ExTB-3 to the safe area	20
5.3.2	Example: Routing via ExConnection Rail (optional accessories).....	21
5.3.3	Appropriate cables & cable entries.....	22
5.3.4	Fusing	23
5.3.5	Plug assignments (RJ45).....	24
5.3.6	Tests prior to switching on the voltage	25
6	Working inside the camera housing.....	26
6.1	Work preparation:.....	26
6.2	Opening the pressure-resistant housing.....	26
6.3	Removing/inserting a SD memory card.....	29
6.4	Status LED	30
6.5	Hardware Reset	30
6.6	Closing of the pressure-resistant housing	30
6.7	Battery.....	31
7	Settings of the lens	32
8	Network access and visualization	34
8.1	Browser Support.....	34
8.2	Assigning the IP address.....	34
8.3	Password/ Identification	35
9	Maintenance/ Modification.....	36
10	Repair.....	36
11	Disposal/ Recycling.....	36
12	Drawings & 3D models.....	36
13	Certificates and further documentation.....	38
14	Notes.....	39

Table of Figures and Charts

Tab. 2-1 Model key	6
Fig. 2-1 Sectional view of SKD02-T	7
Fig. 2-2 Sectional view of ASKD02-T	8
Fig. 2-3 Sectional view of SKDP03-T	8
Fig. 2-4 Sectional view of ASKDP03-T	9
Tab. 2-2. Other technical data	9
Tab. 4-1 Mounting Accessories	12
Fig. 5-1 ExCam IPP1377 Equipotential Bonding	13
Tab. 5-1 Equipotential Bonding	14
Fig. 5-2. Cable gland (KLE) and supply line	14
Fig. 5-3 ExCam IPP1377 T08-VA2.3.K3.BOR2-N.H-xxx.N- T	15
Fig. 5-4. ExCam IPP1377 T08-VA2.3.K3.BOR2-N.H-005.N- P	15
Fig. 5-5. ExCam IPP1377 T08-VA2.3.K3.BOR2-LL.H-005.N- P	15
Fig. 5-6 Video Tutorial ExtB-3	16
Tab. 5-2. Wire assignment of terminal box ExtB-3 (without heater)	16
Tab. 5-3 Wire assignment of terminal box ExtB-3 (model N/ASKD02-T)	17
Tab. 5-4. Wire assignment of terminal box ExtB-3 (integrated heater)	17
Tab. 5-5 Wire assignment of terminal box ExtB-3 (model LL/ASKDP03-T)	18
Fig. 5-7 Sample circuit of terminal box ExtB-3 (without heater)	18
Fig. 5-8 Sample circuit of terminal box ExtB-3 (heater integrated)	19
Fig. 5-9 Photo of the wired terminal box ExtB-3	19
Fig 5-10 ExtB-3 -> Safe area.....	20
Fig. 5-11 ExtB-3 -> ExConnection Rail.....	21
Fig. 5-12 Ex-d cable selection	22
Fig. 5-13 Barrier gland.....	23
Tab. 5-6 Recommendation for fusing	23
Fig. 5-14 Plug assignment, RJ45.....	24
Fig. 6-1 Removing the weather protection roof (1/2) (this illustration is an example)	27
Fig. 6-2 Removing the weather protection roof (2/2) (similar illustration).....	27
Fig. 6-3 Opening the ExCam IPP1377 (similar illustration).....	28
Fig. 6-4. Mounting adapter with built-in components	29
Fig. 7-1. User Interface for setting the zoom and focus	32
Tab.7-1 Lens Data	32
Fig. 8-1 Axis IP Utility	35

History of revisions

Product: ExCam® IPP1377
 Title: User Manual for ExCam® IPP1377
 Doc. -Id. 220721-PT08BA-ES-ExCam-IPP1377_en_rev.02.docx
 Author: Eva Schneider, Grad. Eng. (UAS)
 Created: 21.07.2022

Rev. Index	Date	Name	Comment	Approved by the ATEX Supervisor
0	21.07.2022	E. Schneider	Compilation of the document	
1	19.01.2023	E. Schneider	Change of the EAC-Ex certificate	
2	22.01.2024	E. Schneider	Additional picture in chapter "Electrical Connection"	

1 Introduction

The ExCam IPP1377 is a powerful mega-pixel IP camera of the latest generation, with 5-megapixel resolution at 2592 x 1944 pixels. It is certified according to ATEX, IECEx and EAC-Ex. The camera has a high-definition television resolution. It is equipped with a powerful remote zoom and focus lens (with i-CS).

The ExCam series is certified both in accordance with the European (ATEX) and international (IECEx) directive. The explosion-protected housing is approved for ATEX group II for zones 1, 2, 21 and 22 including the explosion groups IIC / IIIC. The T08 ExCam certification allows not only stationary device installation but also mobile applications (hand-held use, etc.). To see other approvals, please visit our website at www.samcon.eu.



When designing the ExCam IPP1377, we focused very much on safety, mechanical precision and a high quality stainless steel.

2 Technical data

2.1 Explosion protection

Identification marks

acc. to Directive 2014/34/EU:

 II 2G (zone 1 and 2)
 II 2D (zone 21 and 22)
 I M2 ¹

Explosion protection (gas):

Ex db IIC T6 Gb

Explosion protection (dust):

Ex tb IIIC T80°C Db

Explosion protection (mining):

Ex db I Mb

Protection class:

IP66/68 (IEC /EN 60529)

Transport/storage temperature:

-40°C...+65°C

Ambient temperature (EX):

-10°C...+60°C (Type...N.H)

-60°C...+60°C (Type...LL.H)²

Named testing laboratory:

TÜV Rheinland (number 0035)

EU type approval certificate:

TÜV 18 ATEX 8218X (2018)

IECEx Certificate of Conformity:

TUR 18.0023X (2018)

EAC-Ex TUR Report:

TC RU C-DE.HA65.B.01652/22

Other certificates:

see <https://www.samcon.eu/en/products/network/excam-ipp1377/>

¹ Certification for mining only for models with armoured cable and plug termination.

² The temperature class must be reduced to T5.



Attention!
The instructions stated on the type plates have to be observed!

2.2 Illustration of the model key

1) Ex product-name	2) Type	3) Housing-combination	4) Temp.-range	5) Cable length [m]	6) Cable termin.
ExCam IPP1377	T08-	VA2.3.K3.BOR2-	N.H-	005.N-	P-
	T08-	VA2.3.K3.BOR2-	N.H-	005.N-	T-
	T08-	VA2.3.K3.BOR2-	N.H-	005.A-	P-
	T08-	VA2.3.K3.BOR2-	N.H-	005.A-	T-
	T08-	VA2.3.K3.BOR2-	LL.H-	005.N-	P-
	T08-	VA2.3.K3.BOR2-	LL.H-	005.N-	T-
	T08-	VA2.3.K3.BOR2-	LL.H-	005.A-	P-
	T08-	VA2.3.K3.BOR2-	LL.H-	005.A-	T-

Tab. 2-1 Model key

Explanations:

- 1) **ExCam IPP1377** = Functional camera description of the ExCam Series (technical data/ specification of the individual camera module)
- 2) **T08** = SAMCON Production- Type 08
- 3) **VA2.3.K3.BOR2** = T07 ex d housing (stainless steel 1.4404) with large diameter $\varnothing_{VA2}=113\text{mm}$
VA2.3.K3.BOR2 = T07 VA2.3 housing with maximum body length ($L_{,R} = 310\text{mm}$)
VA2.3.K3.BOR2 = K3 cable gland flange
VA2.3.K3.BOR2 = Borosilicate sight glass DIN7080 (standard, for video cameras within visible spectral range: $\lambda = 350\dots2000$ [nm] and photografical infrared range (NIR), not suitable for thermographic applications (MIR/ FIR)
- 4) **N.X** = Normal ambient temperature range, no heater installed ($T_{\text{amb}} > -10^{\circ}\text{C}$)
N.H= High temperature ($T_{\text{amb}} < +60^{\circ}\text{C}$)
LL.H= PTC heater installed ($T_{\text{amb}} > -60^{\circ}\text{C}$)
LL.H= High temperature battery installed ($T_{\text{amb}} < +60^{\circ}\text{C}$)
- 5) **005.N** = Length of the connection line in meter at delivery; 5m is the standard cable length, max. cable length is: 005...100 [m]
005.N = Non armoured cable
005.A = Armoured cable
- 6) **P** = Plug- termination (standard)
 CAT6, RJ-45 network plug (heavy duty), AWG 26-22, contact assignment acc. To specification EIA/TIA-568B
- T** = Terminal Box termination (optional)
 4 x PoE Mode A connection (camera PoE)
 24VDC (Heater) (see chapter electrical connection)

2.3 Electrical parameters of the camera

Supply of 24 V DC for the heating:

Voltage supply:	24 V DC
Power consumption:	approx. 40W @ -60°C (temperature-dependent)

Power supply of the camera over Ethernet (PoE):

Voltage supply:	PoE, IEEE 802.3af/802.3at type 1 class 3
Reference voltage:	+48 V DC (44...54 V DC)
Maximum power consumption:	10.7 W
Typical power consumption:	5.4 W

2.4 Connection cable Ex-d - Ex-e

Description:	Data transfer and power supply of the camera module (compliant with DIN EN 60079-14)
Jacket colour:	Green (GN), similar to RAL3001

2.4.1 Connection cable for models without heater (SKD02-T/ASKD02-T)

Systemcable SKD02-T:

Outside diameter:	8.9 ± 0.3 mm
Bending radius:	8 x D _a when installed and 4 x D _a after relocation
Data line:	4 x 2 x AWG23/1 CAT.6
Properties:	PUR halogen-free, flame-retardant, UV-resistant, chemical resistance, shielded

Quick link:

https://www.samcon.eu/fileadmin/documents/en/60-Assembling%26mounting/SKD02-T_Datasheet.pdf

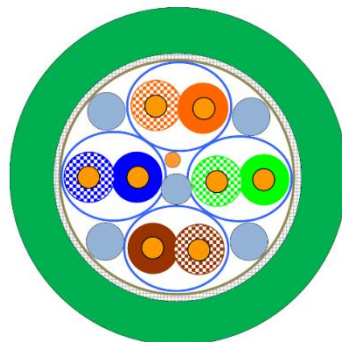

Fig. 2-1 Sectional view of SKD02-T

Systemcable ASKD02-T:

Outside diameter:	12.0 ± 0.4 mm
Bending radius:	20 x D _a when installed and 10 x D _a after relocation
Data line:	4 x 2 x AWG23/1 CAT.6
Properties:	PUR halogen-free, flame-retardant, UV-resistant, chemical resistance, shielded (see www.samcon.eu)

Quicklink:

https://www.samcon.eu/fileadmin/documents/en/60-Assembling%26mounting/ASKD02-T_Datasheet.pdf

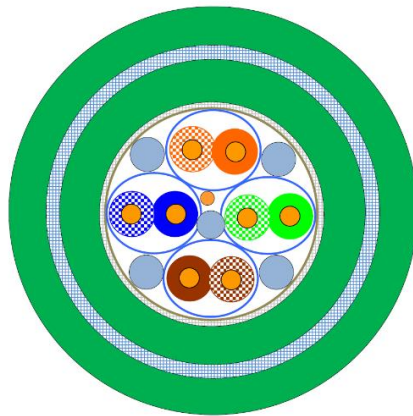

Fig. 2-2 Sectional view of ASKD02-T

2.4.2 Connection cable for models with heater (SKDP03-T/ASKDP03-T)
Systemcable SKDP03-T:

Outside diameter:	12.40 ± 0.3 mm
Bending radius:	8 x D _a when installed and 4 x D _a after relocation
Data line:	4 x 2 x AWG23/1 CAT.6
Performance elements:	3G1.5 (BK-BU-GN/YE)
Properties:	PUR halogen-free, flame-retardant, UV-resistant, chemical resistance, shielded

Quick link:

https://www.samcon.eu/fileadmin/documents/en/60-Assembling%26mounting/SKDP03-T_Datasheet.pdf

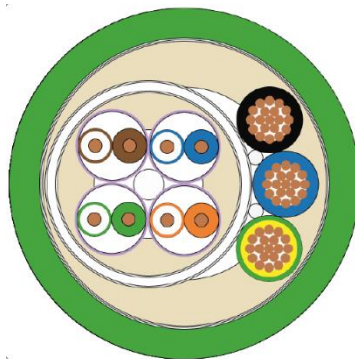

Fig. 2-3 Sectional view of SKDP03-T

Systemcable ASKDP03-T:

Outside diameter:	15.50 ± 0.6 mm
Bending radius:	15 x D _a when installed and 10 x D _a after relocation
Data line:	4 x 2 x AWG23/1 CAT.6
Performance elements:	3G1.5 (BK-BU-GN/YE)
Properties:	PUR halogen-free, flame-retardant, UV-resistant, chemical resistance, shielded

Quicklink:

https://www.samcon.eu/fileadmin/documents/en/60- Assembling%26mounting/ASKDP03-T_Datasheet.pdf

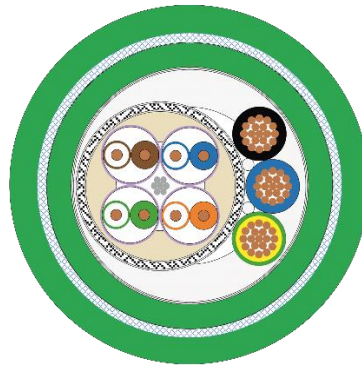

Fig. 2-4 Sectional view of ASKDP03-T

2.5 Video-technical characteristics

We use the AXIS P1377 network camera in a pressure-resistant enclosure. For details, please refer to the Product Documentation, video-technical data of AXIS®:

<https://www.axis.com/products/axis-p1377>



2.6 Other technical data

	Camera (Ex-d)	Terminal box (Ex-e)
Permissible ambient temperature	-10°C ... +60°C (for PoE power supply) -60°C ... +60°C (In the event of additional 24 V DC power supply)	-60°C ... +55°C
Protection class as per EN 60529/IEC 529	IP66/68 (Test conditions: 24h/3m water column 5°C)	IP66
Housing material	stainless steel, mat. no. 1.4404	polyester resin
Weight	about 7.8 kg	about 1 kg
Dimensions	D113mm x 310mm	145mm x 145mm x 71mm

Tab. 2-2. Other technical data

3 Safety Instructions

Please absolutely observe the safety directions stated in the Ex-installation instructions of the T08 ExCam series!



Quick link:

<https://www.samcon.eu/fileadmin/documents/en/22-Ex-Network-Cameras/ExCam-Series-T08-EX-Installation-Manual-2020.pdf>

It is absolutely mandatory to observe the national safety regulations and regulations for prevention of accidents, as well as the safety instructions given below in this User Manual!



Attention!

Cameras of the type T08 ExCam are not suitable for use in zone 0 and zone 20. The ambient temperature, temperature class and explosion group as stated on type plate must be observed! Alterations are not permitted! The camera is to be operated in sound conditions and in the intended way.



Attention!

Only original parts of SAMCON Prozessleittechnik GmbH may be used for repairs. Repairs concerning the explosion protection may only be carried out in accordance with the nationally applied regulations and by SAMCON Prozessleittechnik GmbH.



Attention!

Prior to installation, take external sources of heat or cold into account! The temperature ranges prescribed for storage, transportation, and operating must be adhered to!



Attention!

Observe the warnings given on the type plate:

“WARNING – DO NOT OPEN IN HAZARD AREAS“



The use in hazardous areas with regard to temperature and dust layers is defined in the respective national regulations.



When installing the ExCam, adhere to the requirements of the EN/IEC 60079-14.

4 Installation

For erecting and operating the camera, the relevant national regulations, as well as the generally accepted rules of technology shall prevail. Before mounting the camera, thoroughly check it for any transport damage, especially on the housing and cable. Installation, electrical connection and the first start must only be carried out by qualified specialists.

Work preparation:



Attention!

Prepare your work carefully and in accordance with the relevant regulations.



Attention!

Depending on classification of hazard areas, a work approval has to be obtained.

When you open the pressure-resistant enclosure under voltage, it is absolutely necessary to prevent potentially explosive atmosphere!

To ensure the best image quality delivered by the network camera, plan the installation site carefully (consider light conditions, object distance or size, angle and minimum object distance to the focus).

- Use appropriate tools and aids.
- When working, ensure a safe stand.
- Make sure that any static charge is avoided



Attention!

Please observe the national security, installation and accident prevention regulations (e.g. DIN EN 60079-14) and the safety instructions in this User Manual, as well as the ones in the Installation Guidelines!



Attention!

Adhere to the provisions of the IECEx, ATEX and EX installation instructions for mounting and commissioning!

The ExCam[®] IPP1377 consists of a flame-proof camera housing (Ex-d) and, optionally (models with a terminal box ...-T), a terminal box of a high degree of safety (Ex-e). Both units are connected via a reinforced 5 m cable. Mount the camera according to the desired field of view. Install the terminal box so that a good accessibility is provided, in order to facilitate electrical connection.



Attention!

Please pay attention to the national and local regulations for mounting heavy loads. If in doubt, take appropriate security measures.

Drawings for drill hole patterns and further information can be viewed on our product page:

Quick link:

<https://www.samcon.eu/en/products/network/excam-ipp1377/>



Option mounting accessories

Wall bracket WMB-...		WALL MOUNT BRACKET WMB-VA2.3 Wall bracket for devices of T08-VA2.3 series Suitable for hanging the camera on walls. Material: stainless steel 1.4404 Load bearing: 45 kg Dimensions: 445 x 140 x 185 mm
Weather protec- tion roof WPR-...		WEATHER PROTECTION ROOF WPR-VA2.3 Weathershield for cameras of the T08-VA2.3- Series
Pole adapter PMB-...		WALL MOUNT BRACKET PMB-VA2.3 Pole adapter for VA wall mount Material: stainless steel 1.4404 Suitable for pole diameters between 50 and 105 mm Load-bearing capacity: 45 kg Dimensions: 120 x 180 (x 130 bei Mast Ø 60 mm)

Tab. 4-1 Mounting Accessories

5 Electrical connection



Attention!

The electrical connection of the equipment may only be carried out by officially qualified and skilled personnel!



Attention!

It is absolutely necessary to ground the ExCam® series housing via a PA connection.



Attention!

Please observe the national security, installation and accident prevention regulations (e.g. DIN EN 60079-14) and the safety instructions in this User Manual, as well as the ones in the Installation Guidelines!

The delivered ExCam® IPP1377 is equipped with an electrical connection cable of the type (A)SKD02-T (models N.H) or the type (A)SKDP03-T (models LL.H). The maximum transmission range from the camera to the next active network interface is 100 meters and can be individually specified by the client. The user is NOT authorised to do electrical connection procedures inside the pressure-resistant enclosure.

5.1 Potential equalization

The potential equalization/grounding of the camera body is absolutely necessary, in order to avoid static charges and thus formation of sparks. For this purpose, a screw terminal is provided at the rear side, at the bottom (right) (see Figure 5.1). The cross-section of the equipotential bonding should comply with the National Ground Rules (at least 4 mm²).

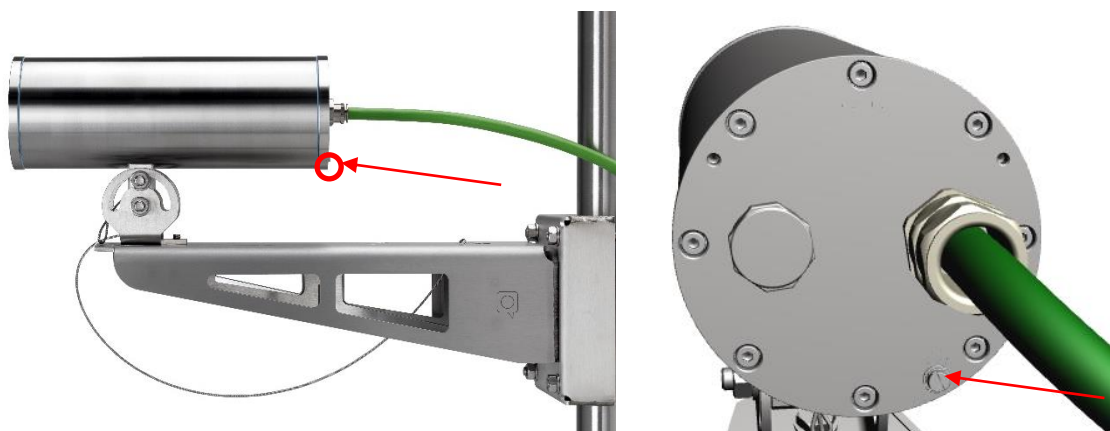

Fig. 5-1 ExCam IPP1377 Equipotential Bonding

Wiring table:

Potential	Colour (IEC 60757)	Cross-section	Comment
PA	GN/YE	4 mm ² (rigid)	Terminal: slotted screw M4x0.7 (DIN 84) with washer Ø9mm (DIN 125A), Keep 3Nm tightening torque!

Tab. 5-1 Equipotential Bonding

5.2 Connection and Fusing

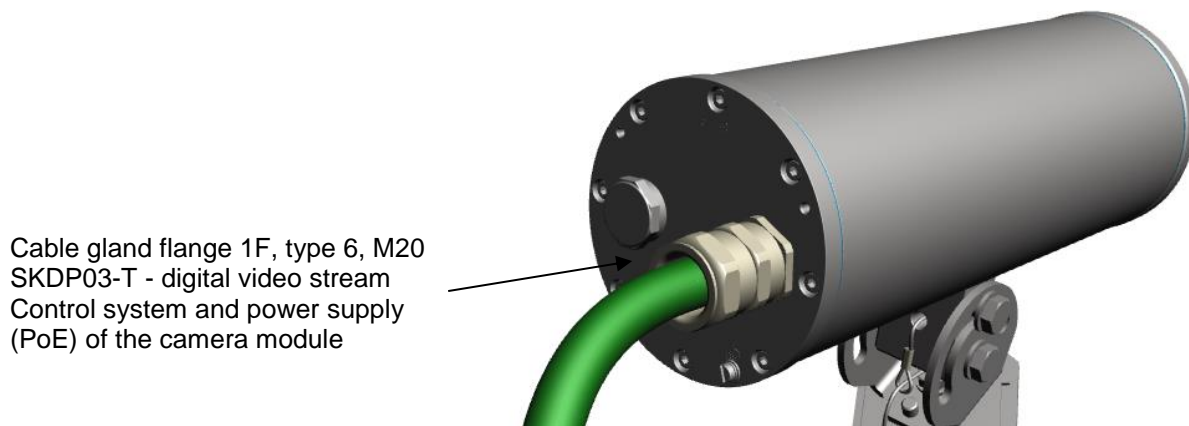

Fig. 5-2. Cable gland (KLE) and supply line

The green system cable is intended for communication and data transfer to the connected network devices and, at the same time, for voltage supply (PoE) to the camera. To ensure the power supply of ExCam IPP1377 (*Powered Device/ PD*), it is necessary to make sure that the power-over-Ethernet provider (*Power Sourcing Equipment/ PSE*) on the connection side (for example PoE Midspan PoE injector, switch, etc.) fulfils the specification IEEE 802.3af and 802.3at type 1 Class 3 ("*classification current: 26-30 mA @48VDC, max. feed-in power (power source equipment): 15.4 W, maximum offtake (power device): 6.49 - 12.95 W*"). The data transfer of the ExCam IPP1377 series is done via a 100 Mbit/s Ethernet connection (100BASE-TX).

The figures 5.3 and 5.4 illustrate the potential cable terminations of the ExCam IPP1377. Possible terminations are: terminal box or plug.

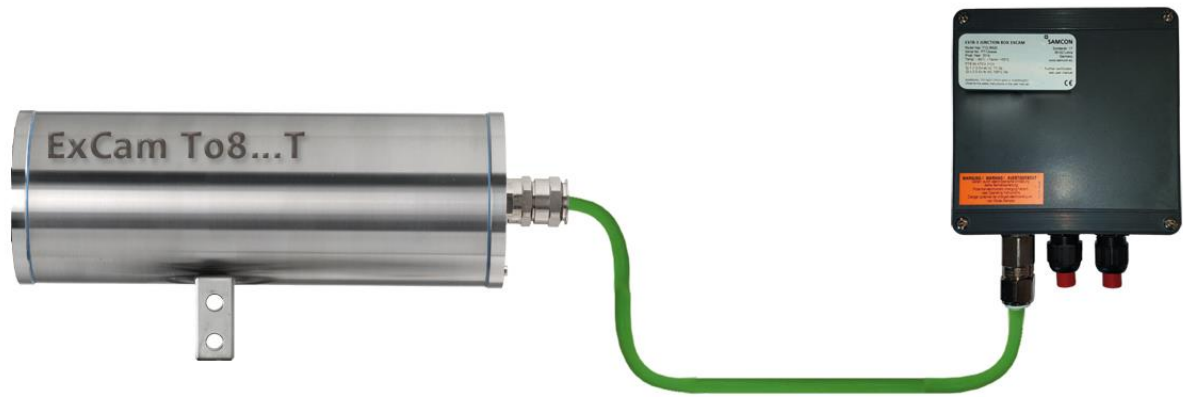

Fig. 5-3 ExCam IPP1377 T08-VA2.3.K3.BOR2-N.H-xxx.N-I



Fig. 5-4. ExCam IPP1377 T08-VA2.3.K3.BOR2-N.H-005.N-P

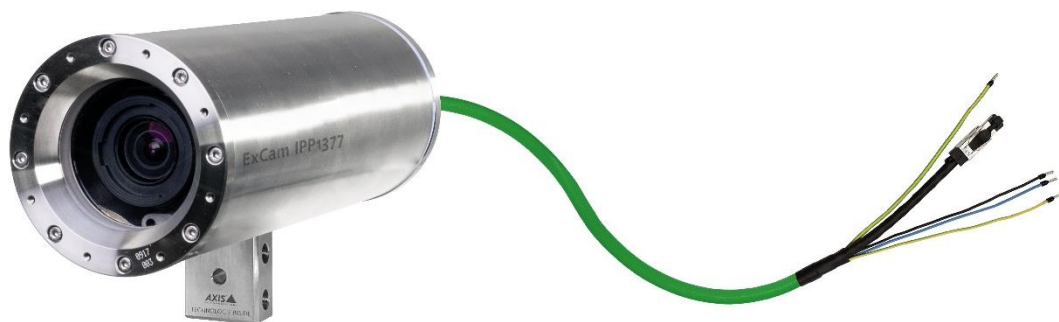

Fig. 5-5. ExCam IPP1377 T08-VA2.3.K3.BOR2-LL.H-005.N-P



Attention!
Never open the Ex-e terminal box under voltage!



Attention!
Adhere to the international installation regulations for connection chambers with increased safety (Ex-e).



Attention!
Adhere to the separate Usual Manual for the Ex-e connection chamber attached in the annex.

Video Tutorial:

Please view our video tutorial:

“SAMCON 01 Wiring the cable SKDP03-T to the junction box ExTB-3”

<https://go.samcon.eu/v01>



Fig. 5-6 Video Tutorial ExTB-3

The pin assignment of the SKD02-T is executed in accordance with the standard EIA/TIA-568B for 100BaseTX and 24VDC, as follows:

Camera (Ex-d) (T568B)	Colour SKD02-T (IEC60757)	Terminal ExTB-3	Cross-sectional surface	Comment
Tx+	WH / OG	1	0.26 mm ²	Solid conductor
Tx-	OG	2	0.26 mm ²	Solid conductor
Rx+	WH / GN	3	0.26 mm ²	Solid conductor
Rx-	GN	4	0.26 mm ²	Solid conductor
(PoE +48 VDC)	WH / BU	5	0.26 mm ²	Solid conductor
(PoE +48 VDC)	BU	6	0.26 mm ²	Solid conductor
(PoE GND)	WH / BN	7	0.26 mm ²	Solid conductor
(PoE GND)	BN	8	0.26 mm ²	Solid conductor
GND/SHD	YE / GN	PE	2.5 mm ²	Flex

Tab. 5-2. Wire assignment of terminal box ExTB-3 (without heater)

The pin assignment of the ASKD02-T is executed in accordance with the standard EIA/TIA-568B for 100BaseTX and 24VDC, as follows:

Camera (Ex-d) (T568B)	Colour ASKD02-T (IEC60757)	Terminal ExTB-3	Cross-sectional surface	Comment
Reinforcement	YE / GN	PE	2.5 mm²	Flex
Tx+	WH / OG	1	0.26 mm ²	Solid conductor
Tx-	OG	2	0.26 mm ²	Solid conductor
Rx+	WH / GN	3	0.26 mm ²	Solid conductor
Rx-	GN	4	0.26 mm ²	Solid conductor
(PoE +48 VDC)	WH / BU	5	0.26 mm ²	Solid conductor
(PoE +48 VDC)	BU	6	0.26 mm ²	Solid conductor
(PoE GND)	WH / BN	7	0.26 mm ²	Solid conductor
(PoE GND)	BN	8	0.26 mm ²	Solid conductor
GND/SHD	YE / GN	PE	2.5 mm²	Flex

Tab. 5-3 Wire assignment of terminal box ExTB-3 (model N/ASKD02-T)

The pin assignment of the SKDP03-T is executed in accordance with the standard EIA/TIA-568B for 100BaseTX and 24VDC, as follows:

Camera (Ex-d) (T568B)	Colour SKDP03-T (IEC60757)	Terminal ExTB-3	Cross-sectional surface	Comment
Tx+	WH / OG	1	0.26 mm ²	Solid conductor
Tx-	OG	2	0.26 mm ²	Solid conductor
Rx+	WH / GN	3	0.26 mm ²	Solid conductor
Rx-	GN	4	0.26 mm ²	Solid conductor
(PoE +48 VDC)	WH / BU	5	0.26 mm ²	Solid conductor
(PoE +48 VDC)	BU	6	0.26 mm ²	Solid conductor
(PoE GND)	WH / BN	7	0.26 mm ²	Solid conductor
(PoE GND)	BN	8	0.26 mm ²	Solid conductor
GND/SHD	YE / GN	PE	2.5 mm²	Flex
L+	BK	9	1.5 mm ²	L+ 24VDC
L-	BU	10	1.5 mm ²	L- 24VDC
PE	YE / GN	PE	1.5 mm²	PE

Tab. 5-4. Wire assignment of terminal box ExTB-3 (integrated heater)

The pin assignment of the ASKDP03-T is executed in accordance with the standard EIA/TIA-568B for 100BaseTX and 24VDC, as follows:

Camera (Ex-d) (T568B)	Colour ASKDP03-T (IEC60757)	Terminal ExTB-3	Cross-sectional surface	Comment
Reinforcement	YE / GN	PE	2.5 mm ²	Flex
Tx+	WH / OG	1	0.26 mm ²	Solid conductor
Tx-	OG	2	0.26 mm ²	Solid conductor
Rx+	WH / GN	3	0.26 mm ²	Solid conductor
Rx-	GN	4	0.26 mm ²	Solid conductor
(PoE +48 VDC)	WH / BU	5	0.26 mm ²	Solid conductor
(PoE +48 VDC)	BU	6	0.26 mm ²	Solid conductor
(PoE GND)	WH / BN	7	0.26 mm ²	Solid conductor
(PoE GND)	BN	8	0.26 mm ²	Solid conductor
GND/SHD	YE / GN	PE	2.5 mm ²	Flex
L+	BK	9	1.5 mm ²	L+ 24VDC
L-	BU	10	1.5 mm ²	L- 24VDC
PE	YE / GN	PE	1.5 mm ²	PE

Tab. 5-5 Wire assignment of terminal box ExTB-3 (model LL/ASKDP03-T)

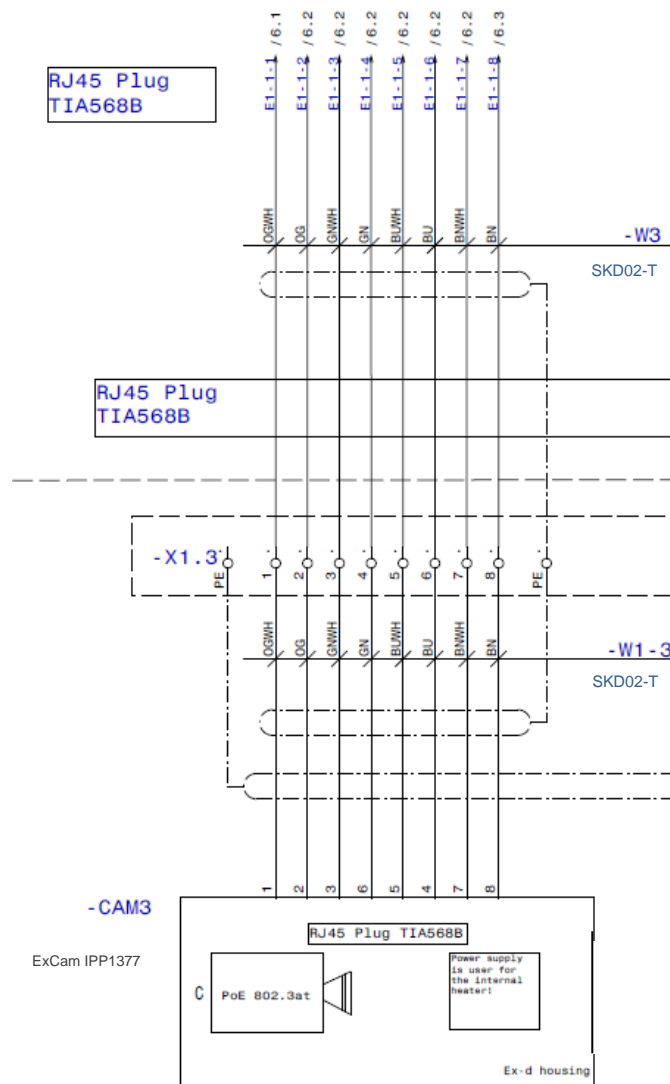

Fig. 5-7 Sample circuit of terminal box ExTB-3 (without heater)

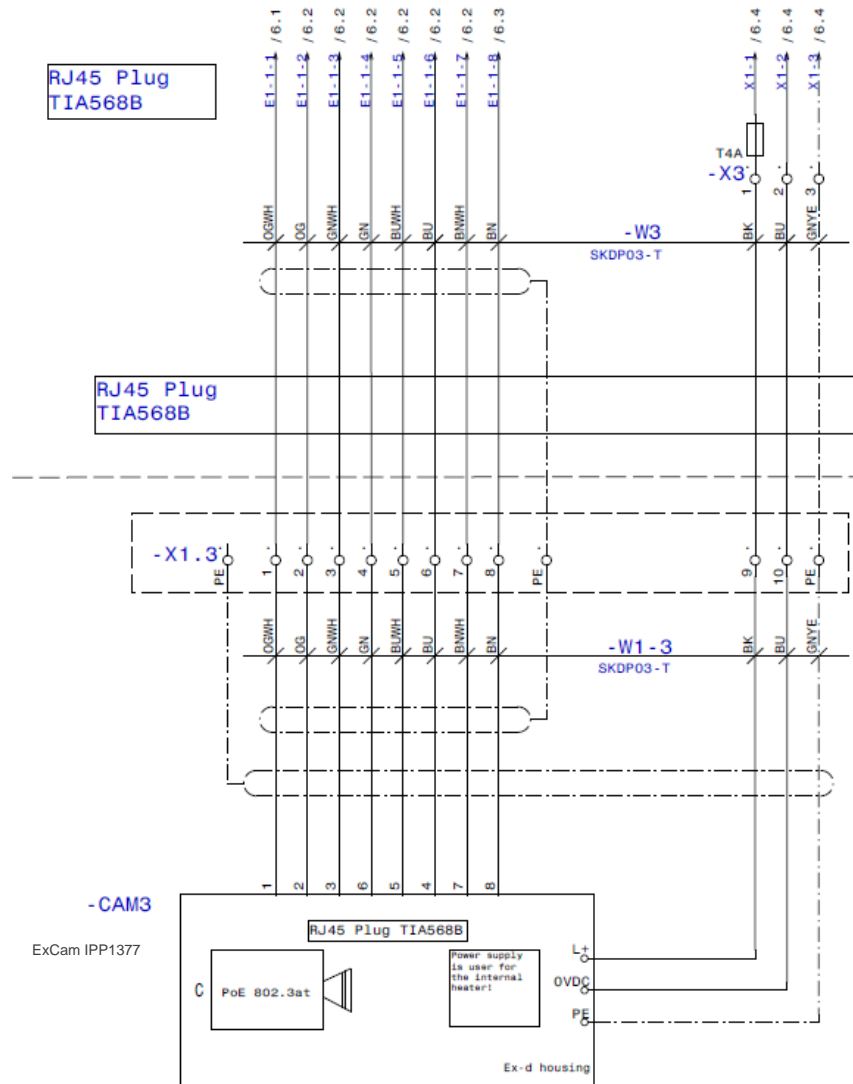

Fig. 5-8 Sample circuit of terminal box ExTB-3 (heater integrated)

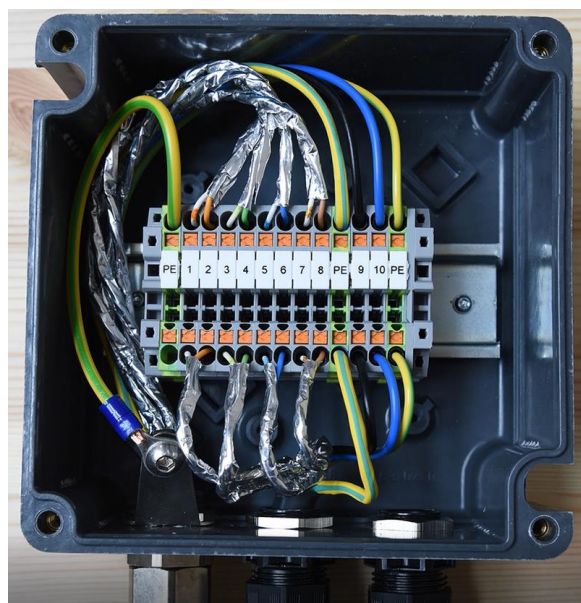

Fig. 5-9 Photo of the wired terminal box ExTB-3



Attention!

Introduce the foiling up to about 15 mm close to the terminals, in order to prevent alien crosstalk. Make sure that the foiling cannot cause any short circuit of the data pairs!



Attention!

Bring the twisted pair composite up to about 10 mm close to the terminals, in order to ensure interference immunity.



Attention!

Use only terminals approved by SAMCON.



Attention!

Finally, check your network installation with a Class-D Link Test.

5.3 Example: external connection and fusing via the terminal box

There are several options of routing the ExTB-3 terminal box in a safe area:

5.3.1 Example: direct routing from the ExTB-3 to the safe area

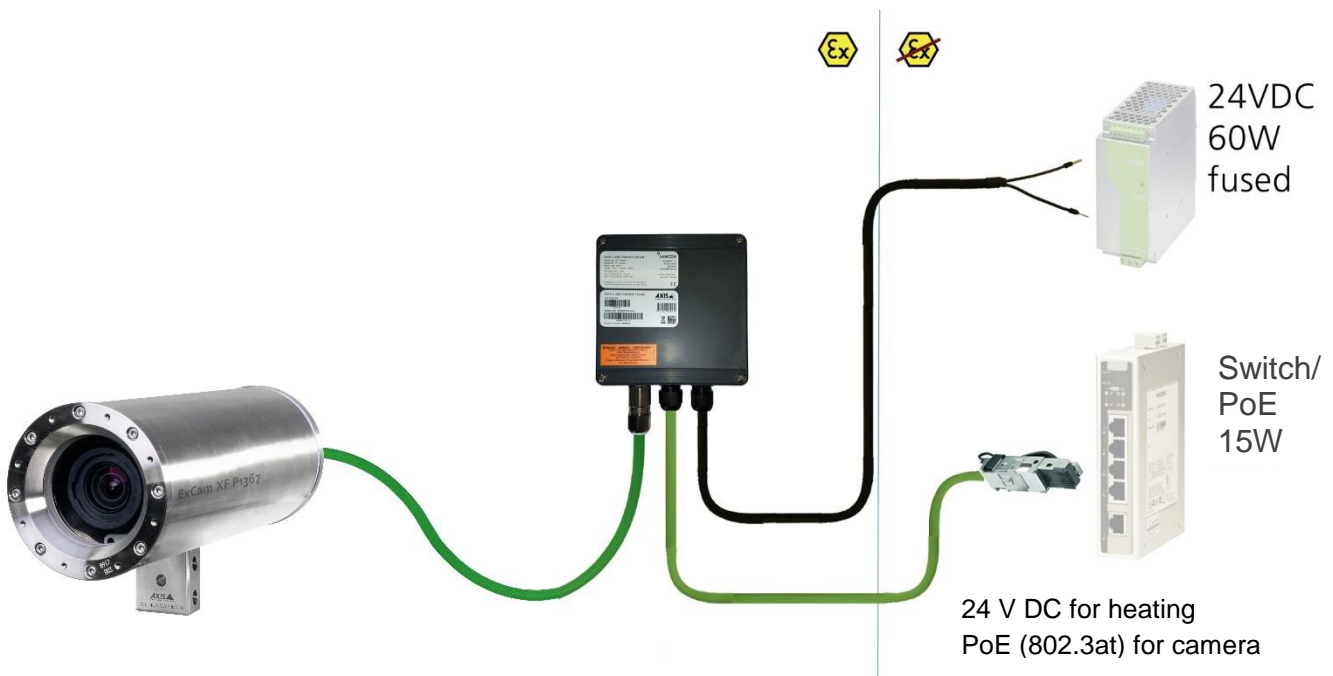

Fig 5-10 ExTB-3 -> Safe area

In the case of direct routing from ExTB-3 to the safe area, the power supply and the voltage signal are led from the safe area to the terminal box. Please observe the terminal box assignment, as described above.



Attention!
Cables and wires must comply with the requirements of the IEC 60079-0/1/7 & 14.



Attention!
The supply line must have a sufficient cross-section. The cable protection must comply with national and international regulations.

5.3.2 Example: Routing via ExConnection Rail (optional accessories)

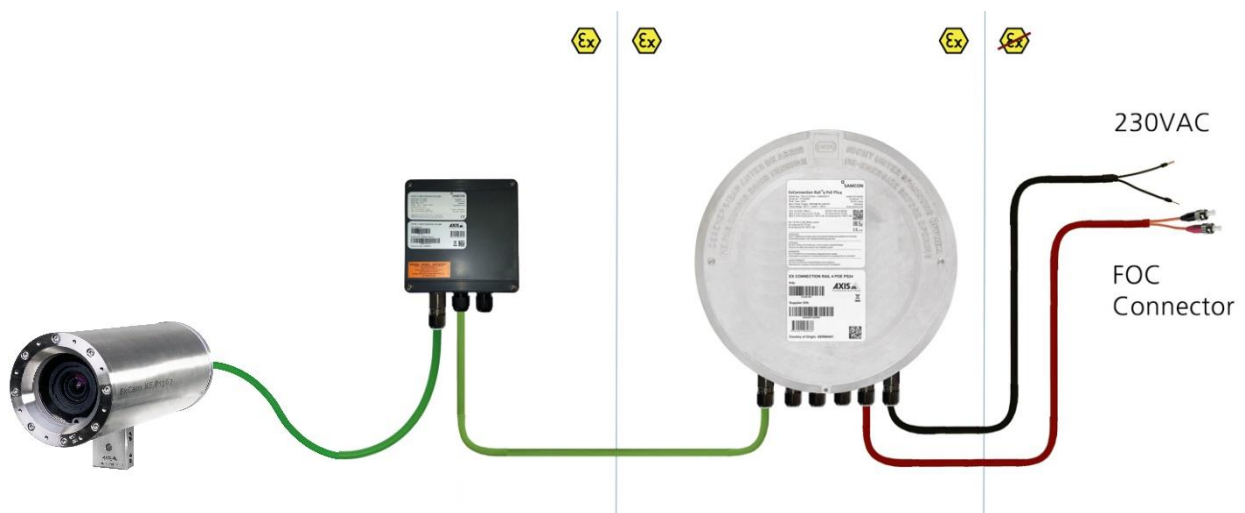

Fig. 5-11 ExTB-3 -> ExConnection Rail

In the case of routing the ExTB-3 into an ExConnection Rail, larger installation distances can be covered.

Please note:

In hazardous areas, the ExConnection Rail (optional accessories) acts as a PoE+ switch, a media converter from copper to fibre-optic cable, as well as a power supply for the cameras.

5.3.3 Appropriate cables & cable entries

An integral part of the device safety is the correct selection of the cables, wires and cable entries.



Attention!
Cables and wires must comply with the requirements of the IEC 60079-0/1/7 & 14.



Attention!
The supply line must have a sufficient cross-section. The cable protection must comply with national and international regulations.

To view non-binding configuration and planning guidelines, please visit our website:



Perhaps our video will help you:

"Cables for flameproof devices in potentially explosive atmospheres"

<http://go.samcon.eu/video-cable-ex>



Fig. 5-12 Ex-d cable selection

Particularly for installations requiring a suitable barrier gland, make sure that you handle them correctly and observe the rules and notes given in the respective mounting and assembly instructions.

We show the basic procedures in the following video tutorial:

"SAMCON 02 Mounting and installing Ex-d barrier glands to ExConnection Rails"

<https://go.samcon.eu/v02>

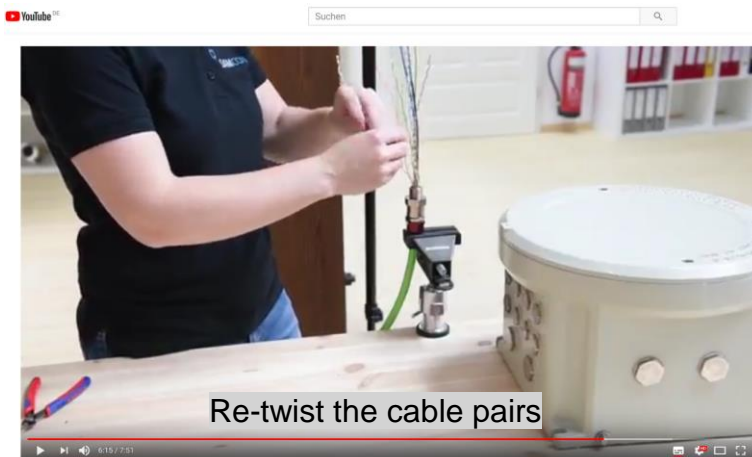

Fig. 5-13 Barrier gland

5.3.4 Fusing

PoE power supply requires no fuses.

The power supply fusing depends on the cable cross-section and length.



Attention!

Recommendation for fusing relates to 40W@24VDC at 100 meters 1.5 mm²



Attention!

When the heating switches on, high current peaks occur! Use slow-blow fuses.



Attention!

Please pay attention to the national and international regulations regarding selectivity and line protection.

Potential/ Wire no.	Colour (IEC60757)	Conductor	Voltage	Maximum power consumption/fusing:
L+ / 1	BK	1.5mm ² , stranded wire	+24 V DC	40 W of continuous power Fine-wire fuse (L+) 4000 mA -T- slow-blow (high inrush load!)
L- / 2	BU	1.5mm ² , stranded wire	0 VDC / GND	
PE	YE/GN	1.5mm ² , stranded wire	PE	

Tab. 5-6 Recommendation for fusing

5.3.5 Plug assignments (RJ45)

The data transfer of the ExCam IPP1377 uses a 100 Mbit/s Ethernet connection (100BASE-TX). If the cable termination uses a plug, the latter should be plugged into the RJ45 PoE slot of the network device (PSE). Prior to connecting it to the camera, the network device (PSE) can already be supplied with power, hence there is no „power ON“ priority which has to be observed.



Attention!

Use appropriate RJ45 plugs! Check the cable shielding, cross-section and the outside diameter!



Attention!

It is imperative to ensure a correct routing of the individual wires according to the EIA/TIA-568B"



Attention!

Finally, check your network installation with a Class-D Link Test.

Detailed instructions on how to connect a RJ45 plug are available in our video tutorial: "SAMCON 03 Mounting and installing the RJ45 jack to SAMCON cables" <https://go.samcon.eu/v03>

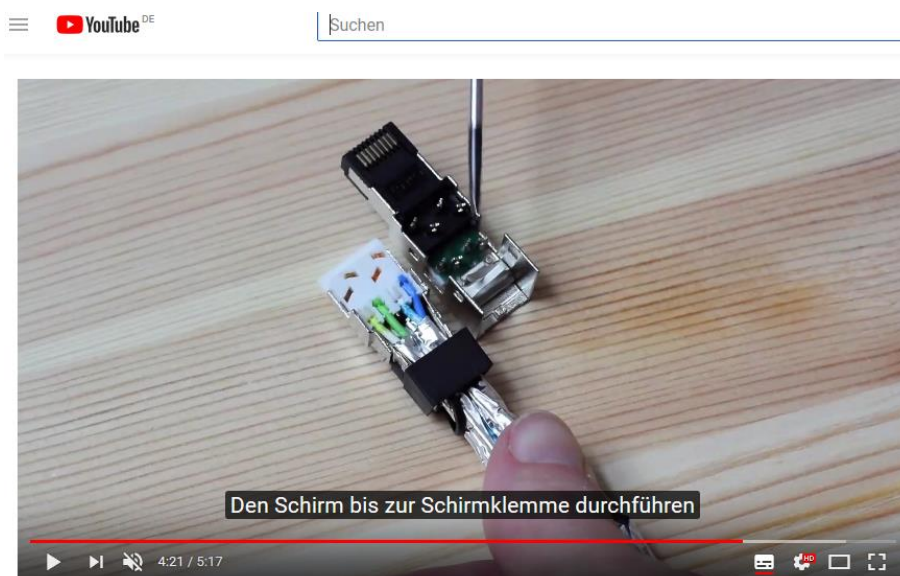

Fig. 5-14 Plug assignment, RJ45

5.3.6 Tests prior to switching on the voltage



Attention!

Prior to starting the device, perform all tests as indicated by the national regulations. Furthermore, check the correct function and installation of the device in accordance with this User Manual and other applicable regulations.



Attention!

Incorrect installation and operation of the camera may lead to a loss of warranty!



Attention!

Do not switch on the camera at temperatures below 0°C!

6 Working inside the camera housing

The customer may open the housing only if it is absolutely necessary. Only exchanging the SD memory card or a hardware reset are reasons for this.

Open the pressure-resistant housing extremely carefully! After having finished the work, securely re-close it and ensure that the explosion protection is restored! To do this, you need to proceed step by step, as described in the instructions below.

6.1 Work preparation:



Attention!

Prepare your work carefully and in accordance with the relevant regulations.



Attention!

Depending on classification of hazard areas, it is imperative to obtain a work approval first!

If you adjust the camera yourself or open the pressure-resistant enclosure (Ex-d) under voltage, it is absolutely imperative to prevent potentially explosive atmosphere!

6.2 Opening the pressure-resistant housing



„WARNING – MUST NOT BE OPENED IN HAZARD AREAS“

Note: Depending on classification of hazard areas, a work approval has to be obtained.

Even after switching on the power supply, it is absolutely imperative to avoid potentially explosive atmosphere when opening the camera housing. Opening the housing requires disassembly and working in a safe (i.e. non-explosive!) area.



Attention!

Pay attention not to damage the thread surface of the flame-proof gap.



Attention!

Pay attention not to damage the housing seals. Keep them clean!

If the ExCam IPP1377 is equipped with a weather protection roof (optional accessory), remove the roof before you start working! To do so, untighten the 4x12mm lens screws M4*0.7 at the front and rear sides of the bracket holders (Fig. 6-1).

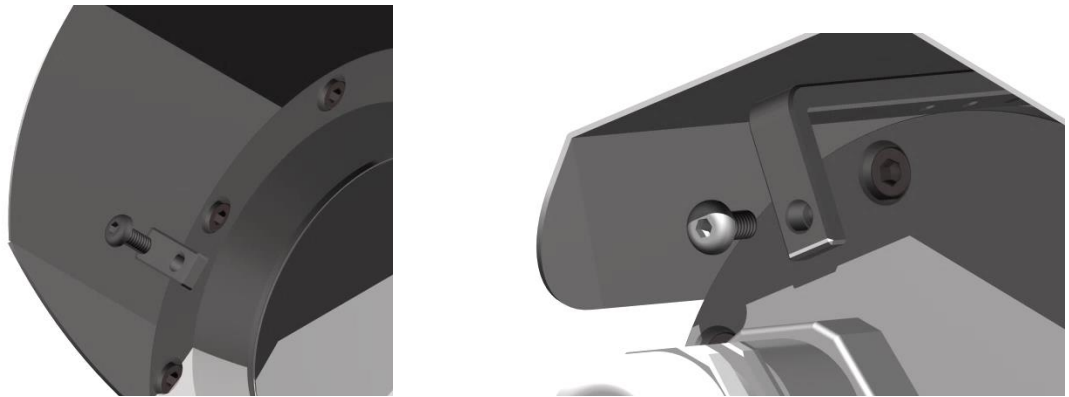

Fig. 6-1 Removing the weather protection roof (1/2) (this illustration is an example)

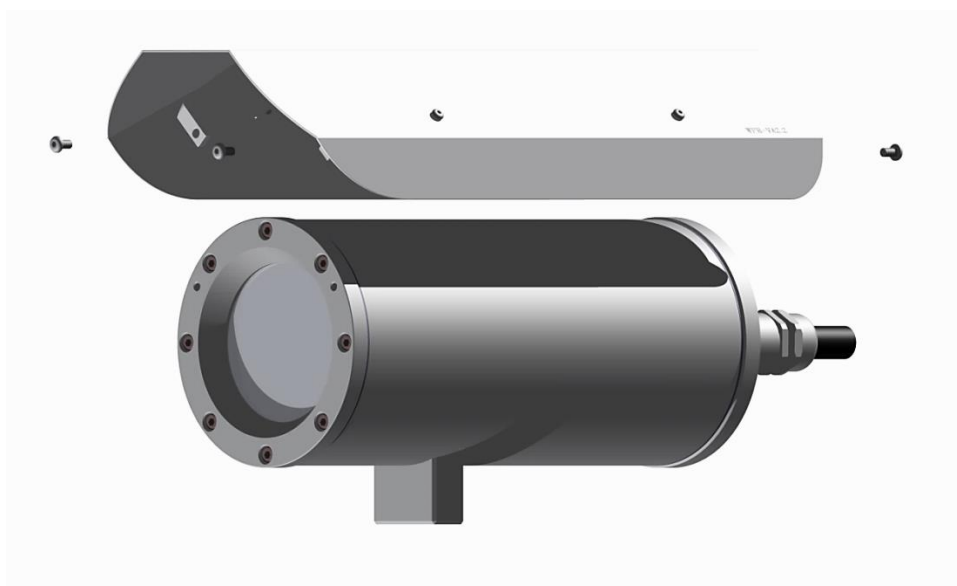

Fig. 6-2 Removing the weather protection roof (2/2) (similar illustration)

To open the ExCam IPP1377's stainless steel housing (T07 VA2.3.x.x) of, loosen the eight cylinder-head hexagon screws (DIN 912/ ISO 4762) together with their spring rings (DIN 127A) on the rear side of the cable and power supply flange (see Fig. 6-3).

Caution: Do not touch the screw threads with your skin or clothes! On the threads, there is LOCTITE® 243™ (chemical basis is dimethacrylate ester) applied to prevent the bolted connection from unintentional loosening because of impacts and vibrations and to seal them tightly. It is not permitted for the customer to open the front-side sight glass flange! There is no need of such an action.

Carefully pull out the cable and supply flange to the rear, as straight as possible. Because of negative pressure, it may be difficult to remove the flange. The cylindrical clearance fit (H8f7 - DIN ISO 286) of the camera body and flange may not be tilted! Risk of damage to the flame-proof gap (DIN EN 60079-1:2012)!

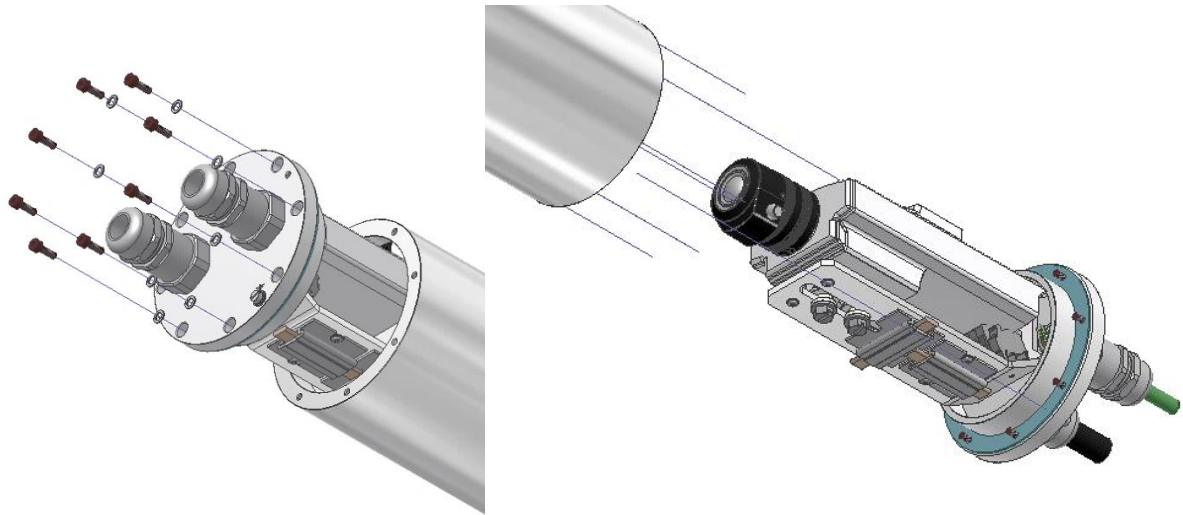

Fig. 6-3 Opening the ExCam IPP1377 (similar illustration)

Attention: The mounting adapter with the housing's PTC heater, camera module and optics, as well as the CB06 temperature control and (if applicable) auxiliary relays and terminal box are fixed on the cable and supply flange. Dealing with these components, too, you have to work very carefully and precisely in order to avoid canting and damage to the in-built components!

Caution: Do not touch the cylindrical fit surface with your skin or clothes! On the surface, there is oil lubricating paste to protect the surface against fretting corrosion and mechanical stresses.

When you open the housing, heed that you do not damage the GYLON® flat seal (blue, RAL5012) and do not make it dirty. The flat gasket is loosely attached to the cable and power supply flange. It is fixed only by the bolted connections!



Attention!

Make sure not to damage the surface of the drill hole and the shaft (fitting) of the flame-proof gap.



Attention!

Pay attention not to damage the seals. Keep them clean!

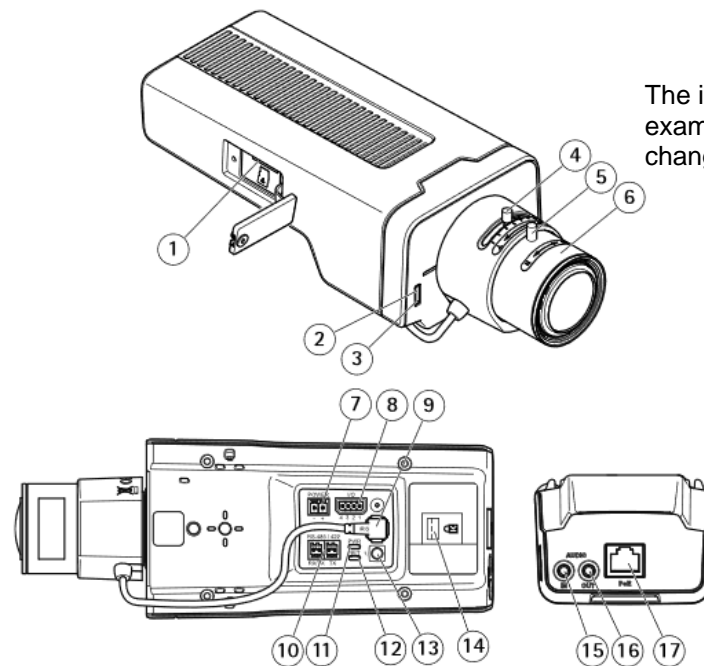

The illustration is only an example, the lens is changed

- 1 MicroSD card slot
- 2 Status LED
- 3 Built-in microphone.
- 4 Zoom slider
- 5 Setting screw for the focus ring
- 6 Focus ring
- 7 Power supply (DC)
- 8 I/O port
- 9 Iris connector
- 10 RS485/422 port
- 11 Power LED
- 12 Network LED
- 13 Control key
- 14 Safety slot
- 15 Audio input
- 16 Audio output
- 17 Network connection port (PoE)

Fig. 6-4. Mounting adapter with built-in components

6.3 Removing/inserting a SD memory card

Note:

The ExCam IPP1377 disposes of a micro SDHC memory card slot (see Fig. 6-4 1). Saved video files can be played and deleted via the web interface. They are also available in a download list. Moreover, the videos available on the memory card can also be accessed via an FTP server in the network.

If the memory card has to be replaced by the user, it should be, as far as possible, empty and pre-formatted with an ext4 or vFAT file system.



When touching electrical components, observe potential equalization (grounding of the body): carry electrostatic-discharge clothes, a PE wristband etc.!

6.4 Status LED

The user can see the Status LED (Fig. 6-4) only if the camera housing is open.

6.5 Hardware Reset

To re-set all parameters of the ExCam IPP1377 (including the IP address) to default setting, a hardware reset has to be carried out.

The parameters can be either reset via the web interface or manually. If the camera in the network can no longer be reached or its state is uncontrollable, the reset should be performed manually. To do so, proceed as follows:

1. Disconnect the camera installation module (Axis P1377) from the power supply.
2. Press and hold the control button 13 (see the illustration 6-4) and, at the same time, connect the system to the voltage supply (PoE).
3. Press and hold the control button until status indicator 2 (Fig. 6-4) lights yellow (wait about 30 seconds).
4. Release the control button. When the status indicator lights green (it can take about 1 minute), P1377 will be reset to the factory settings axis. If there is a DHCP server in the network, the IP address will be the following: 192.168.0.90 (subnet masking 255.255.255.0).
5. IP address and password can be redefined. If the hardware reset is not satisfactory, or the network camera shows serious conflicts, or does not work as usually (errors in the browser visualisation, frozen images, control commands no longer processed, slowing down of the system, etc.), it may be necessary to re-install the current firmware, or to install an update (see Chapter 7).

6.6 Closing of the pressure-resistant housing

For closing the housing, proceed in reverse order as when opening. Use exclusively original screws included in the supply.

The cable and power-supply flange (K3) is fixed by 8 cylinder-head screws M4*0.7 (ISO metric right-turning) with 12 mm thread length (DIN 912/ ISO 4762, grade 6g). Materials of bolted connections are identical to the pressure-resistant stainless steel housing (standard material no. 1.4404 AISI316L). Check whether the threaded holes are undamaged and clean. Before closing, it is also absolutely imperative to check the flame-proof gap (circular cylindrical fit).

**Attention!**

If any mechanical damages occurred to the fitting gap, it is no longer allowed to use the housing!

**Attention!**

Do not lock-in any foreign objects in the housing.

Dismantled screw locks (spring washers DIN 127A) must be used again.

The GYLON® gasket must be used in undamaged condition, according to the flange hole pattern, and placed between the flange and the body. The lateral position of the flat surface/contact surface is arbitrary.

If, when closing the housing, you see that the surface of the fitting gap is dirty or insufficiently lubricated, clean it with a clean cloth and de-grease it with a suitable cleaning agent. Then re-grease it with lubricant suitable for this specific application (e.g., Molykote® P-40 gel for standard applications or special grease OKS 403 in the event of heavy seawater influence).

The screwed connections of flange and body components must always be tightened *crosswise* at a torque of **3 Nm**! Do not tighten the screws too strongly! It can cause rupture of the cylinder head or over-stretching the threads, and thus leading to an impairment of the pressure resistance or ignition protection class!



Cylinder-head bolts for explosion-proof connection of the camera body with the flange component must always be tightened at a 3 Nm torque - crosswise and evenly!

6.7 Battery

ExCam IPP1377 is equipped with a high-temperature resistant Panasonic button cell BR2330A/VAN. This cell supplies energy to the internal real time clock (RTC). The customer is not allowed to replace the battery! In this case, please contact the manufacturer.

7 Settings of the lens

The ExCam IPP1377 lens can be set up only via the web interface or the visualization software. The user cannot do any mechanical settings on at remote zoom lens. To configure the focus and tele-range, you can use the control function (slider) via the web interface and mouse command (see Fig. 7-1).

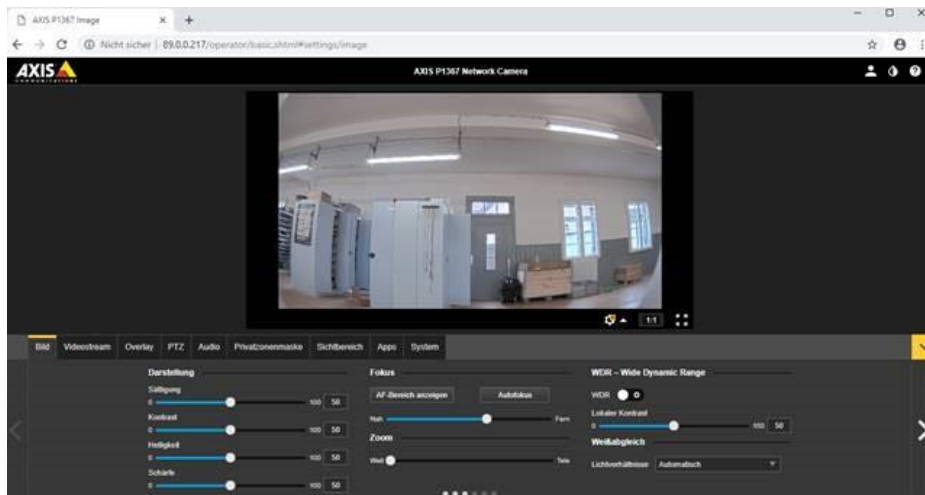

Fig. 7-1. User Interface for setting the zoom and focus

This step is only necessary if the camera factory settings are unsatisfactory, or if user settings (focus, sharpness, digital zoom, etc.) to be done via the web interface do not allow the user to achieve the desired results.

	P 1377
Lens type	Varifocal, IR-corrected, CS-mount, mega-pixel
Iris control	ICS iris, F1.2/ 2.7 mm
aspherical technology	No
Focal length	2.8 – 8.5 mm
Image angle, horizontal	103° (wide) - 38° (tele)
Control characteristic (iris)	automatic (the camera module contains an analogue circuit)
MOD (min. object distance)	0.30 m (wide) 1.00 m (tele)

Tab.7-1 Lens Data



Please note!

If not agreed otherwise, the ExCam® IPP1377 is pre-configured by the manufacturer to the maximum sensor resolution and low image compression (high image quality and high network bandwidth). The focus is optimized for objects at approximately 10 metres distance.

The focus of the ExCam IPP1377 network camera is optimised by the manufacturer to about 10 m object distance. The complete viewing angle is located in the "wide" area. This means a horizontal viewing angle of 103°. Usually, no adjustment is required. To focus the objects at a smaller or greater distance, or to change the zoom range (wide -> tele), you can change the lens settings, as follows:

1. Via a web browser (Mozilla Firefox, MS Internet Explorer, etc.), open the user interface of ExCam IPP1377 (for network access, see Chapter 8). Navigate in the "Setup" menu via the "Basic Setup" pull-down menu to the "Focus" settings.
2. Follow the shown instructions and first click on the "Open iris" button. If this button is disabled, this means that the iris is already open.
3. Now click on "Reset", to reset the lens level to the default value.
4. Release the zoom and sharpness regulators on the lens, by turning it counter-clockwise. By moving the two regulators, adjust the zoom strength and image sharpness. Check the image quality in the window below.
5. Re-tighten the zoom and sharpness regulators.
6. The click on the button "Fine-tune focus automatically" in the configuration menu and wait until the automatic optimization is finished.
7. To re-enable the iris, click "Enable iris". If the button is disabled, this means that the iris is already activated.
8. If necessary, you can make further settings in the "Advanced" tab.

Please note:

Before you start the automatic fine tuning, adjust the image sharpness as precisely as possible with the aid of the sharpness regulator or focus wizard. The sharpness regulator usually provides the best results.

8 Network access and visualization

The most important procedures of the camera's initial commissioning are described below. The configuration menu of the web surface allows an intuitive navigation and offers several configuration possibilities. For detailed documentation and information how to use the web Interface, please see the User Manual for Axis or visit the following website:

<https://www.axis.com/products/axis-p1377>



The delivered ExCam IPP1377 is set to the applicable net frequency (50Hz or 60Hz). If the camera is used at a location with a differing net frequency, the image might start to flicker, particularly in surroundings with fluorescent tubes. In such a case, the applicable settings have to be carried out within the menu "System Options > Advanced > Plain Config".

User: root
Password: root

8.1 Browser Support

A list of the currently supported web browsers, operating systems, required add-ons, etc. can be viewed at:

http://www.axis.com/techsup/cam_servers/tech_notes/browsers.htm



8.2 Assigning the IP address

The ExCam IPP1377 is intended for use in an Ethernet network and requires an IP address to access and control it. In most of today's networks, a DHCP server is integrated. This server automatically assigns an IP address.

If there is no DHCP server available in the network, the IP default address of ExCam IPP1377 is "**192.168.0.90**" (**subnet masking 255.255.255.0**). With the "AXIS IP Utility", it is possible to determine the IP address under Windows; the included USB stick contains this application.



If it is not possible to assign the IP address, it might be necessary to change the firewall settings!

The "AXIS IP Utility" tool automatically recognizes all ExCam devices and visualises them in the device list. It can also be used to manually assign a static IP address. For this purpose, the ExCam IPP1377 network camera should be installed in the same physical network segment (physical subnet) as the computer on which the AXIS IP Utility is running. The network signature of ExCam IPP1377 is "AXIS P1377" (see Fig. 8-1). MAC address and serial number for clear device identification are also detected and displayed.



Name	IP-Adresse	Seriennummer
AXIS F44 - ACCC8E266424	89.0.0.149	ACCC8E266424
AXIS Q6045 Mk II - ACCC8E4F51D9	172.22.21.143	ACCC8E4F51D9
ExCam IP1365 → AXIS P1365 - ACCC8E29187A	89.0.0.107	ACCC8E29187A
Test08 Axis M1145-L	89.0.0.110	ACCC8E3B8197
IO Module - Axis P8221	89.0.0.194	00408CADBEOC
Show room - ExCam IPQ1755 (right monitor)	89.0.0.47	ACCC8E0E0E4E
ExCam IPP1377 → AXIS P1377 - ACCC8E4F68A2	172.22.21.61	ACCC8E4F68A2
AXIS M3014 - ACCC8E2CB572	89.0.0.208	ACCC8E2CB572
Outdoor - Bus stop - Axis P1346	89.0.0.152	00408CD65BF8
Test10 ExCam IP1354	89.0.0.112	00408CF23CCC
Bunker - ExCam vario (Axis Q7401)	89.0.0.144	00408CA1A3A0
Show room - ExCam miniZoom (left monito...	89.0.0.46	00408CCC0845
AXIS Q7404 Channel 2 - 00408CCC0843	89.0.0.43	00408CCC0843
Process - ExCam vario (Axis Q7404_1)	89.0.0.51	00408CCC0842
Hall - Axis 233D	89.0.0.122	00408C82E5C1
Engine room - ExCam IPM1145-L	89.0.0.140	ACCC8E39C80C
Test13 ExCam IPQ1755	89.0.0.115	00408C8F18E9
Outdoor - Gate N - Axis P1346	89.0.0.154	00408CD65BFA
Show room - ExCam IPM1145 SmokeCatcher...	89.0.0.211	ACCC8E3C5A47

Fig. 8-1 Axis IP Utility

8.3 Password/ Identification

The following user name is set at the factory: **root**

The following password is set at the factory: **root**

9 Maintenance/ Modification

The applicable regulations for the maintenance and servicing of electrical devices in potentially explosive atmospheres must be adhered to.

The required maintenance intervals are specific to the individual devices. The operating company has to determine these intervals depending on the application parameters. The maintenance tasks especially include examination of parts on which the ignition protection depends (e.g., proper condition of the casing, seals and cable entry points). If maintenance measures are necessary they have to be initiated and/or executed.

10 Repair

Repairs may only be carried out with original parts of SAMCON Prozessleittechnik GmbH. Damaged pressure-resistant housings have to be replaced completely. If in doubt, send the part in question back to SAMCON Prozessleittechnik GmbH.

Repairs concerning the explosion protection must only be carried out in accordance with nationally applied regulations by SAMCON Prozessleittechnik GmbH or by an electrical technician authorized by SAMCON Prozessleittechnik GmbH. Rebuilding of or alterations to the devices are not permitted.

11 Disposal/ Recycling

When disposing of the device, nationally applicable regulations must be observed.

This Document is subject to alterations and additions.

12 Drawings & 3D models

All drawings, 3D models, certificates and other information are available in the download area of the product page on our website:

Quick link:

<https://www.samcon.eu/en/products/network/excam-ipp1377/>

[Analog Ex Cameras \(CVBS\)](#)
[Network Ex Cameras \(TCP/IP\)](#)
[ExCam IPM3016](#)
[ExCam IPM2036](#)
[ExCam IPP1275](#)
[ExCam IPM114x](#)
[ExCam IPP1377](#)
[cool.Jacket](#)
[ExCam IPQ1645](#)
[ExCam IPQ1615 \(DLPU\)](#)
[ExCam IPQ1785](#)
[ExCam IPQ1715](#)
[ExCam IPP5655](#)
[ExCam IPQ6075](#)
[ExCam IPQ6075-MKII](#)
[ExCam IPP1280 \(thermal\)](#)
[ExCam XI80 \(thermal\)](#)
[ExCam XI410 \(thermal\)](#)
[Modular Ex Cameras](#)
[Robust Cameras \(non-ex\)](#)
[Your Individual Camera \(BTO\)](#)
[Ex-d Camera Enclosures](#)
[Connection Systems](#)
[Cables for Ex-Areas](#)
[Mounting Systems](#)
[Wash and Wipe Equipment](#)
[Software](#)

Downloads:

- [Datasheet](#)
- [3D-Model](#)
- [Usermanual](#)
- [CAD-files \(DXF\)](#)
- [Ex Installation Manual](#)
- [ATEX Type Examination](#)
- [IECEX Cert.-of-Conformity](#)
- [IA-Certificate](#)
- [EAC-Ex-Certificate](#)
- [PESO-Certificate](#)
- [EU Dec. of Conformity](#)

ExCam[®] IPP1377

The ExCam IPP1377 is a powerful IP-megapixel camera (5 megapixels) for use in hazardous areas – **not only offering superb HDTV resolution (2592 x 1944) but also a powerful remote zoom and focus lens (i-CS)**. The ExCam series is certified according to European regulations (ATEX) as well as international ones (IECEX), EAC-Ex and more.

Features.

- Broad Certification Landscape for Hazardous Areas (ATEX, IECEX & EAC-Ex and more)
- Arctic-Temperature-Control (-60°C)
- Single-Cable-Solution (PoE / 24VDC)
- Protection Level of IP68 (IEC 60529)
- High Resolution: 2592x1944 (5 MP at 25/30 fps)
- Powerful Remote Zoom and Focus Lens
- Lightfinder and WDR Technologies
- Easy VMS Integration
- Economical

Explosion-proof IP-camera with ATEX-, IECEX- and EAC-Ex-certification

Besides the European regulations (ATEX), the ExCam series is also certified according to international regulations (IECEX) as well as the Russian custom-union (EAC-Ex). The housings' certification comprises ATEX group I (mining) with a low risk of mechanical threat and ATEX group II (Gas and Dust) for zone 1, 2 as well as 21 and 22 including the explosion groups IIC / IIIC with a high risk of mechanical threat. In addition, certification can be extended at any time to cover different markets. For South Africa, for example, this has already been achieved with the MASC (Mining and Surface Certification).

During the ExCam IPP1377's development stage the focus was clearly laid on security aspects as well as mechanical precision and high-quality stainless steels.

Regarding the technical parameters we have pushed the limits of what is feasible: In the media resistance and the ambient temperature we set standards with the ExCam series.

Media resistance and seals

Due to the high-quality materials used for the T07 Series, it is resistant to many media! The particularly designed GYLON (PTFE) flat sealing does not only ensure the housing to be watertight (IP68) but also supports the resistance towards several chemicals. The extremely robust and scratch-proof as well as high-impact resistant borosilicate glass fits perfectly into the high-quality materials of the housing body.

Temperatures

The allowed ambient temperature range of the ExCam IPP1377 starts at -60°C and goes up to +60°C.

If you wish additional technical information, please contact us at:
support@samcon.eu

13 Certificates and further documentation

Certificates and further documentation are available in the download area at the product website:

Quick link:

<https://www.samcon.eu/en/products/network/excam-ipp1377/>

14 Notes



SAMCON

Schillerstrasse 17, 35102 Lohra-Altenvers, Germany
www.samcon.eu, info@samcon.eu
Phone: +49 6426 9231-0, fax: - 31

