

RoughCam[®] IPP1280

User Manual



Table of contents

1	Introduction	4
2	Technical data	5
2.1	Illustration of the model key.....	5
2.2	Electrical parameters of the camera.....	6
2.3	System cable SKD04-T.flex	6
2.4	Video-technical characteristics.....	7
2.5	Other technical data	7
3	Safety Instructions	8
4	Installation	8
5	Electrical connection	10
5.1	Potential equalization	10
5.2	Connection work at the device (terminal box) and fuses	11
5.2.1	Direct routing.....	11
5.2.2	Plug assignments (RJ12) of the sensor unit.....	11
5.2.3	Tests prior to switching on voltage	12
6	Working on the device	13
6.1	Preparation for work:	13
6.2	Hardware Reset	13
6.3	Removing / inserting a SD memory card.....	14
7	Network access and visualization	15
7.1	Browser Support.....	15
7.2	Assigning the IP address.....	15
7.3	Password/ Identification	16
8	Maintenance / Modification.....	16
9	Disposal / Recycling	17
10	Drawings & 3D models.....	17
11	Certificates and further documentation.....	18
12	Notes.....	19

Table of Figures and Charts

Table 2-1 Model key	5
Figure 2-1 Sectional view of SKD04-T.flex	6
Table 2-2 Other technical data	7
Table 4-1 Mounting accessories	9
Figure 5-1 RoughCam IPP1280 Potential equalization	10
Table 5-1 Potential equalization	10
Figure 5-2 RoughCam IPP1280 T10-VA0.1.K1.GER-N.N-xxx.N- P	11
Table 6-2 Pin assignment of the RJ12 plug (SKD04-T.flex)	12
Figure 6-1 Structure of the main unit P12 MkII	13
Figure 7-1 Axis IP Utility	16

History of revisions

Product: RoughCam® IPP1280
 Title: User Manual for RoughCam® IPP1280
 Doc. -Id. 210212-PT10BA-ES-RoughCam IPP1280_en_rev.00.docx
 Author: Eva Schneider, Grad. Eng. (UAS)
 Created on: 22.02.2021

Rev. Index	Date	Name	Comment	Approved by Supervisor
0	22.02.2021	E. Schneider	Compilation of the document	

1 Introduction

The RoughCam IPP1280 is an ultra compact thermal network-camera for use in industrial areas. The camera has a thermal resolution (208x156) and is equipped with an uncooled microbolometer. The RoughCam IPP1280 is a modular network-camera. This means that it consists of two units: the ultra compact sensor unit (lens and image sensor) and the main unit (network, power and memory card slot).

The RoughCam series is suitable for indoor as well as outdoor applications. It is extremely robust and therefore perfect for even the roughest industrial conditions. The stainless steel housing allows additional alloys, a powder coating, or coats of varnishes as well as various mechanical accessories in order to extend the resistance towards extreme environmental conditions (salt water, acid, solar radiation, high mechanical strains etc.). Due to the usage of high-quality PTFE sealings, not only the protection level IP68 is reached but also the chemical resistance is maximized. For more information please visit our website at www.samcon.eu/en

When designing the RoughCam IPP1280, we attached a very high importance to safety, mechanical precision and high quality of stainless steel.

2 Technical data

2.1 Illustration of the model key

1) Product-name	2) Type	3) Housing- combination	4) Temp.- range	5) Cable length [m]	6) Cable termin.
RoughCam IPP1280	T10-	VA0.1.K1.GER-	N.N-	005.N-	P

Table 2-1 Model key

Explanations:

- 1) **RoughCam IPP1280** = Functional camera description of the RoughCam Series (technical data/ specification of the individual camera module)
- 2) **T10** = SAMCON Production- Type 10 cameras for safe areas
- 3) **VA0.1.K1.GER** = T11 housing (stainless steel 1.4404) with small diameter $\varnothing_{VA2}=48\text{mm}$
VA0.1.K1.GER = T11 VA0.1 housing with minimum body length ($L_R = 127\text{mm}$)
VA0.1.K1.GER = K1 cable gland flange
VA0.1.K1.GER = Germanium sight glass, suitable for thermographic applications (MIR/ FIR)
- 4) **N.N** = Normal ambient temperature range ($T_{amb} > -30^\circ\text{C}$)
N.N= No high temperature battery installed ($T_{amb} < +60^\circ\text{C}$)
- 5) **005.N** = Length of the connection line in meter at delivery; 5m is the standard cable length, max. cable length is: 005...25 [m]
005.N = Non armoured cable
- 6) **P** = Plug- termination (standard)
 CAT6, RJ-12 network plug (heavy duty), AWG 26-22, contact assignment acc. To specification EIA/TIA-568B

2.2 Electrical parameters of the camera

Power supply of the camera via Ethernet (PoE):

Voltage supply:	PoE, IEEE 802.3af/802.3at type 1 class 2
Reference voltage:	+4 V DC
Maximum power consumption:	4.0 W
Typical power consumption:	2.5 W

2.3 System cable SKD04-T.flex

Description:	Data transfer and power supply of the camera module
Jacket colour:	Green (GN), similar to RAL 6018
Outside diameter:	8.7 ± 0.3 mm
Bending radius:	8 x D _a when installed and 4 x D _a after installation
Temperature:	-25°C ... +80°C during installation -60°C ... +80°C fixed installed
Data line:	4 x 2 x AWG24/7 blank, CAT.6
Shielding:	Copper, tinned wire 0.10, optical cov. app. 80%
Outer jacket/ Properties:	PUR FHF, halogen-free, flame-retardant (EN 60332-1-2), EMV shielded, suitable for drag chains, (see www.samcon.eu)

Quicklink:

https://www.samcon.eu/fileadmin/documents/en/60-Assembling%26mounting/SKD04-T.flex_Datasheett.pdf

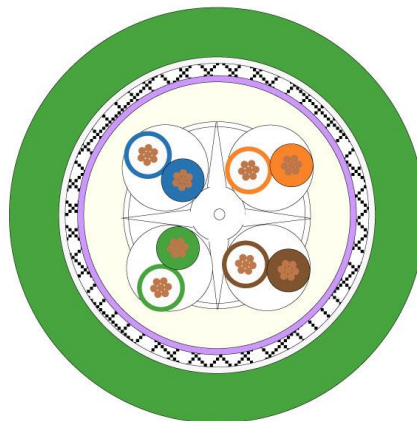

Figure 2-1 Sectional view of SKD04-T.flex

2.4 Video-technical characteristics

We use the AXIS P1280 Network Camera in our enclosure. For details, please refer to the Product Documentation, video-technical data of AXIS®:

<https://www.axis.com/products/axis-p1280-e>



2.5 Other technical data

Protection class: IP 68/IP66 (IEC /EN 60529)

Transport/storage temperature: 0°C...+50°C

Ambient temperature Sensor Unit: -30°C...+60°C

Ambient temperature Main Unit: -20°C...+50°C

	Sensor Unit (Ex-d)	Main Unit
Permissible ambient temperature	-30°C ... +60°C	-20°C ... +50°C
Protection class as per EN 60529/IEC 529	IP68 (Test conditions: 0.5h/8m water column 5°C)	IP66
Housing material	stainless steel, mat. no. 1.4404	polycarbonat (T08-...-P) or aluminium (T08-...-TD)
Weight	about 0.7 kg	0.72 kg (T08-...-P) approx. 4 kg (T08-...-TD)
Dimensions	D48mm x 127mm	16.5mmx46mmx109mm (T08-P) 192mmx192mm (T08-...-TD)

Table 2-2 Other technical data

3 Safety Instructions

Please observe the national safety regulations and regulations for prevention of accidents, as well as to the safety instructions given below in this User Manual!



Attention!

Repairs may only be carried out by using original parts from the manufacturer. Repairs may only be carried out in accordance with the nationally applied regulations and exclusively by the manufacturer.



Attention!

Prior to installation, take external sources of heat or cold into account! The temperature ranges prescribed for storage, transport and operating must be adhered to!

4 Installation

For commissioning and operating the camera, the relevant national regulations, as well as the generally accepted rules of technology shall prevail. Before mounting the camera, thoroughly check it for any transport damage, especially on the housing and cable. Installation, electrical connection and the first start must only be carried out by qualified specialists.

Work preparation:



Attention!

Prepare your work carefully and in accordance with the relevant regulations.

To ensure the best image quality delivered by the network camera, plan the installation site carefully (consider light conditions, object distance or size, angle and minimum object distance to the focus).

- Use appropriate tools and aids.
- When working, ensure a safe stand.
- Make sure that any static charge is avoided.

The RoughCam® IPP1280 consists of a sensor housing (T10) and a Main Unit P12 MkII. The sensor unit is equipped with a flexible cable (5 to 25 m). Mount the sensor unit according to the desired field of view. Install the main unit so that a good accessibility is provided, in order to facilitate electrical connection.

Drawings for drill hole patterns and further information can be viewed on our product page:

Quick link:

<https://www.samcon.eu/en/products/roughcam/roughcam-ipp1280/>



Optional mounting accessories

Wall bracket WMB-...		<p>WALL MOUNT EXCAM VA1.x Wall bracket for devices of T08-VA0-series Suitable for hanging the camera on walls. Material: stainless steel 1.4404 Weight: 0.68 kg Dimensions: 80 x 100 x 205 mm</p>
Pole adapter PMB-...		<p>POLE MOUNT EXCAM VA1.x (-) Pole adapter for VA wall mount Material: stainless steel 1.4404 Suitable for pole diameters between 50 and 105 mm Load-bearing capacity: 45 kg Dimensions: 120x180x130 at masts of Ø 60 mm)</p>
Hinge attachment SCH-...		<p>Hinge attachment SCH-VAx.x Hinge attachment for easy mounting on round sight glasses acc. to DIN 28120/28121 or similar for VA Material: stainless steel AISI 316L/1.4404 Weight: ca. 0.04 kg Dimensions WxHxD [mm]: 29.2x40x73.1</p>

Table 4-1 Mounting accessories

5 Electrical connection



Attention!

The electrical connection of the equipment may only be carried out by qualified and skilled personnel!



Attention!

It is absolutely necessary to ground the RoughCam® series' housing via the PA connection.

The delivered RoughCam® IPP1280 is equipped with an electrical connection cable of the type SKD04-T.flex. The maximum transmission range from the camera to the next active network interface is 25 meters and can be individually specified by the client. The user is NOT authorised to do electrical connection procedures inside the enclosure.

5.1 Potential equalization

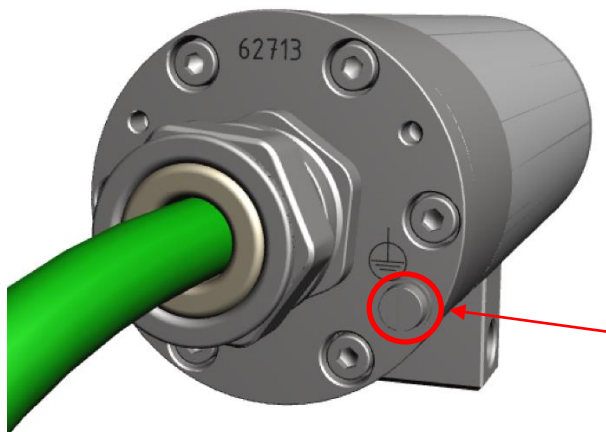

Figure 5-1 RoughCam IPP1280 Potential equalization

Potential equalization/grounding of the camera housing is absolutely necessary, in order to avoid static charges and thus the formation of sparks. For this purpose, a screw terminal is provided at the rear side, at the bottom (right) (see Figure 5-1). The cross-section of the potential equalization should comply with the National Ground Rules (at least 4mm²).

Wiring table:

Potential	Colour (IEC 60757)	Cross-section	Comment
PA	GN/YE	4 mm ² (rigid)	Terminal: Slotted screw M3x0.5 (DIN 84) with washer Ø9mm (DIN 125A), Keep 1.2 Nm tightening torque!

Table 5-1 Potential equalization

5.2 Connection work at the device (terminal box) and fuses

Power supply for the camera (PoE)

Voltage supply:	PoE, IEEE 802.3af/802.3at type 1 class 2
Reference voltage:	+4 V DC
Maximum power consumption:	4.0 W
Typical power consumption:	2.5 W

The figure 5.2 illustrates the cable termination of the RoughCam IPP1280.



Figure 5-2 RoughCam IPP1280 T10-VA0.1.K1.GER-N.N-xxx.N-**P**

5.2.1 Direct routing

At the cable end of the sensor unit, the cable is equipped with an RJ12 ethernet plug with Power over Ethernet (PoE). The plug (Fig. 5-2) is to be connected to the PoE outlet of the Main Unit (P12 MkII, without pressure tight casing).

It is suggested connecting the Sensor Unit with the Main Unit prior to powering the Main Unit. If the Sensor Unit will be unplugged and then re-connected, it is possible that the Main Unit needs to be rebooted. The maximum cable length is 25 m.

5.2.2 Plug assignments (RJ12) of the sensor unit

If the cable of the Sensor Unit needs to be shortened (the cable must not be extended), the plug needs to be disassembled professionally. When re-mounting the plug it is mandatory to observe the correct pin assignment. Usually two strands of the same color code (IEC60757) are connected.

The pin assignment of the SKD04-T.flex is as follows:

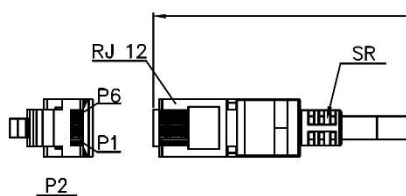

WIRE CONNECTION TABLE			
P1	SIGNAL NAME	WIRE COLOR	P2
1	VCC	Blue/Whitie	5
5	GROUND	Blue	6
2	-DATA	Brown/Whitie	2
3	+DATA	Brown	1
Shell	Drian wire	--	Shell

WIRE CONNECTION TABLE			
P2	CODE	WIRE COLOR	SIGNAL
1	Brown	BN	+ DATA
2	Brown White	BN / WH	- DATA
3	-	-	-
4	-	-	-
5	Blue White	BU / WH	VCC
6	Blue	BU	Ground
SH	Shield	Shield	Drian wire

Table 6-2 Pin assignment of the RJ12 plug (SKD04-T.flex)

It is necessary to make sure that the cable shield is grounded on side of the terminal block!



Attention!

Finally, check your network installation with a Class-D Link Test.

Particularly in EMC critical environments, it is necessary to make sure that the cable shield is grounded on side of the terminal block!

The maximum cable length between camera and terminal box is 25 m.

5.2.3 Tests prior to switching on voltage



Attention!

Prior to starting the device, perform all tests as indicated by the national regulations. Furthermore, check the correct function and installation of the device in accordance with this User Manual and other applicable regulations.



Attention!

Incorrect installation or operation of the camera may lead to a loss of warranty!



Attention!

Do not switch on the camera at temperatures below 0°C!

6 Working on the device

The customer may not open the sensor unit housing.

6.1 Preparation for work:



Attention!

Prepare your work carefully and in accordance with the relevant regulations.

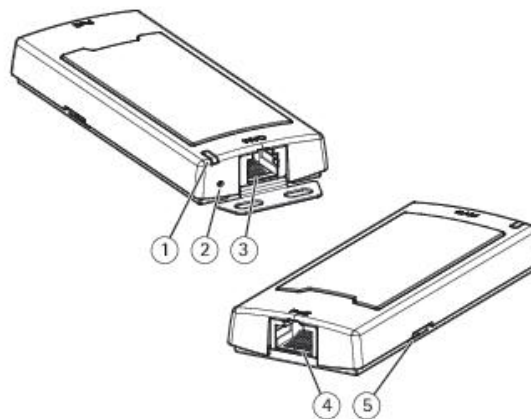

AXIS P12 Mk II Main Unit

- 1. Status-LED
- 2. Steuertaste
- 3. RJ12-Anschluss
- 4. Netzwerk-Anschluss (PoE)
- 5. Einschub für SD-Karte (microSD)

Figure 6-1 Structure of the main unit P12 MkII

6.2 Hardware Reset

To set all the parameters of the RoughCam IPP1280 (including the IP address) to default values, you should run a hardware reset.

The parameters can be reset via the web interface or manually. If the camera placed in the network can no longer be reached or its state is uncontrollable, the reset should be performed manually. To do so, proceed as follows:

1. Disconnect the camera installation module (Axis P1280) from the power supply.
2. Press and hold the control button and, at the same time, connect the system to the voltage supply (PoE).
3. Hold the control button pressed for about 30 seconds.

4. Release the control button. After about a minute, the AXIS P1280 will return to factory defaults. If there is a DHCP server in the network, the IP address will be the following: 192.168.0.90 (subnet masking 255.255.255.0).
5. IP address and password can be redefined. If the hardware reset is not satisfactory or the network camera shows serious conflicts or does not work as usual (errors in the browser visualisation, frozen images, control commands no longer processed, slowing down of the system, etc.), it may be necessary to re-install the current firmware, or to install an update.

6.3 Removing / inserting a SD memory card

Note:

The RoughCam IPP1280 has a slot for a micro SDHC memory card (card not included). Saved video files can be played and deleted via the web interface. They are also available in a download list. Moreover, the videos available in the memory card can also be accessed via FTP server in the network.

If the memory card has to be replaced by the user, it should be, as far as possible, empty and pre-formatted with an ext4 or vFAT file system.



When touching electrical components, observe potential equalization (grounding of the body): carry electrostatic-discharge clothes, a PE wristband etc.!

7 Network access and visualization

The most important procedures of the first starting up the camera are described below. The configuration menu of the web surface allows an intuitive navigation and offers several configuration possibilities. For detailed documentation and information how to use the web Interface, please see the User Manual for Axis or visit the following website:

<https://www.axis.com/products/axis-p1280e>



The delivered RoughCam IPP1280 is set to the applicable net frequency (50Hz or 60Hz). If the camera is used at a location with a differing net frequency, the image might start to flicker, particularly in surroundings with fluorescent tubes. In such a case, the applicable settings have to be carried out inside the menu “System Options > Advanced > Plain Config”.

User: root
Password: root

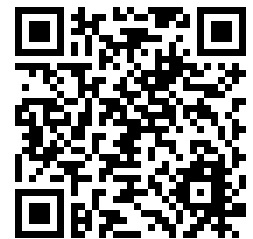

7.1 Browser Support

A list of the currently supported web browsers, operating systems, required add-ons, etc. can be viewed at:

http://www.axis.com/techsup/cam_servers/tech_notes/browsers.htm

7.2 Assigning the IP address

The RoughCam IPP1280 is intended for use in an Ethernet network and requires an IP address to access and control it. In the most today's networks, a DHCP server is integrated. This server automatically assigns an IP address.

If there is no DHCP server available in the network, the IP default address of RoughCam IPP1280 is “**192.168.0.90**” (**subnet masking 255.255.255.0**).

With the “AXIS IP Utility”, it is possible to determine the IP address under Windows; the included USB stick contains this application.



If it is not possible to assign the IP address, it might be necessary to change the firewall settings!

The “AXIS IP Utility“ tool automatically recognizes all RoughCam devices and visualises them in the device list. It can also be used to manually assign a static IP address. For this purpose, the RoughCam IPP1280 network camera has to be installed in the same physical network segment (physical subnet) as the computer on which the AXIS IP Utility is running. The network signature of RoughCam IPP1280 is "AXIS P1280" (see Figure 7-1). MAC address and serial number for clear device identification are also detected and displayed.

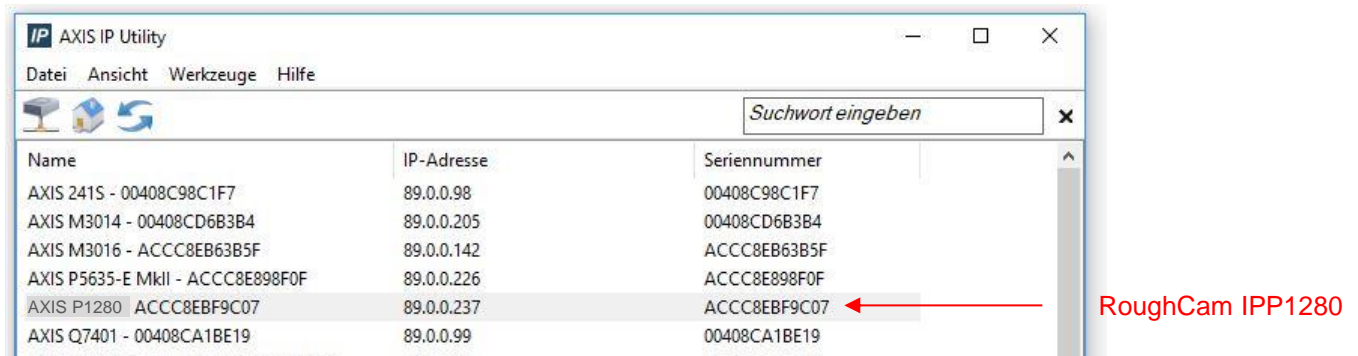

Figure 7-1 Axis IP Utility

7.3 Password/ Identification

The following user name is set at the factory: **root**
 The following password is set at the factory: **root**

8 Maintenance / Modification

The applicable regulations for the maintenance and servicing of electrical devices in potentially explosive atmospheres must be adhered to.

The required maintenance intervals are specific to the individual devices. The operating company has to determine these intervals depending on the application parameters. If maintenance measures are necessary they have to be initiated and/or executed.

Repairs may only be carried out with original parts of SAMCON Prozessleittechnik GmbH. In case of doubt, send the part in question back to SAMCON Prozessleittechnik GmbH.

Reparations must only be carried out in accordance with nationally applied regulations by SAMCON Prozessleittechnik GmbH or by an authorised electrical technician authorised by SAMCON Prozessleittechnik GmbH. Rebuilding of or alterations to the devices are not permitted.

9 Disposal / Recycling

When disposing of the device, nationally applicable regulations must be observed. This Document is subject to alterations and additions.

10 Drawings & 3D models

All drawings, 3D models, certificates and other information are available in the download area of the product page on our website:

<https://www.samcon.eu/en/products/roughcam/roughcam-ipp1280/>

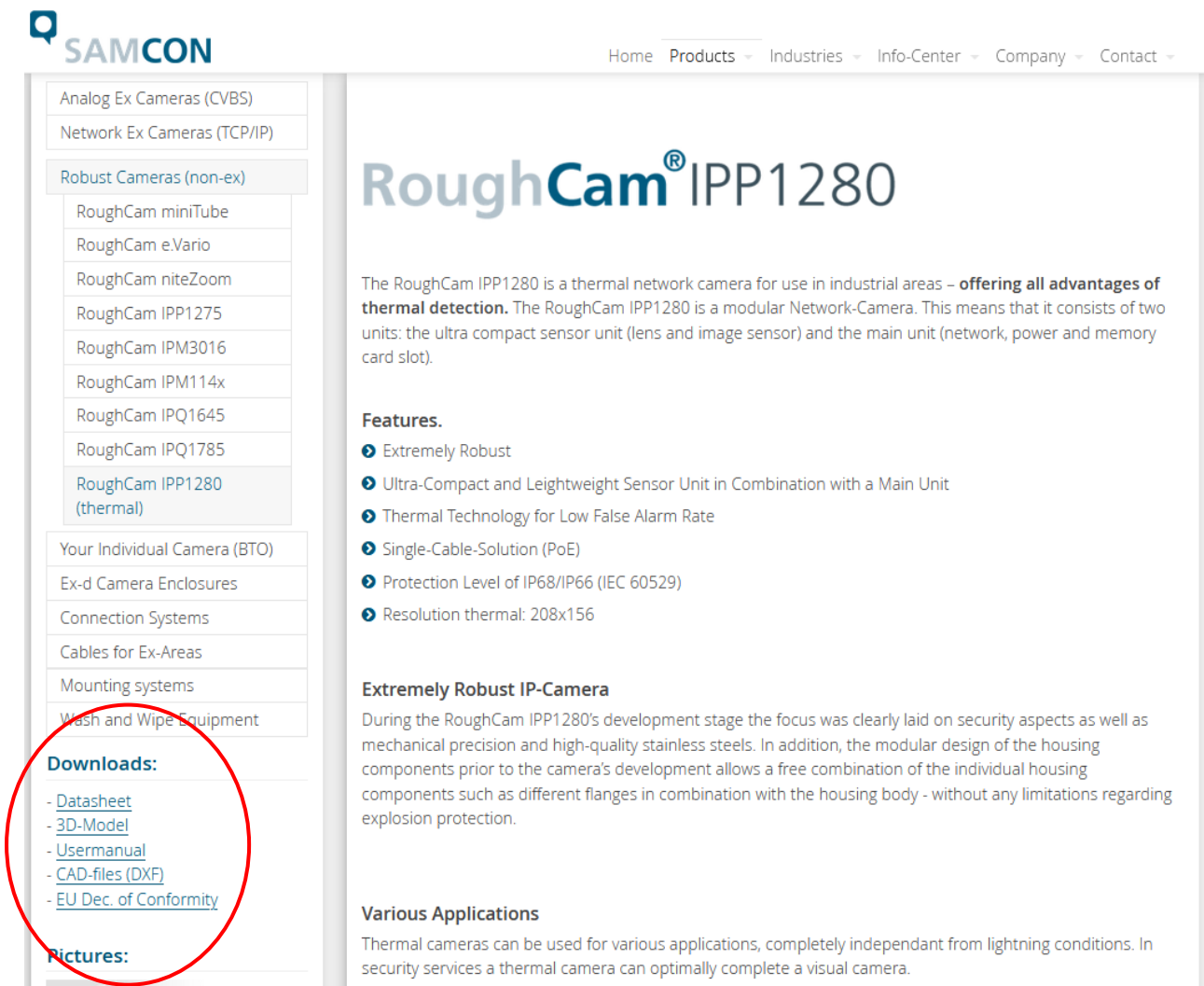

SAMCON Home Products Industries Info-Center Company Contact

Analog Ex Cameras (CVBS)
 Network Ex Cameras (TCP/IP)
 Robust Cameras (non-ex)
 RoughCam miniTube
 RoughCam e.Vario
 RoughCam niteZoom
 RoughCam IPP1275
 RoughCam IPM3016
 RoughCam IPM114x
 RoughCam IPQ1645
 RoughCam IPQ1785
 RoughCam IPP1280 (thermal)
 Your Individual Camera (BTO)
 Ex-d Camera Enclosures
 Connection Systems
 Cables for Ex-Areas
 Mounting systems
 Wash and Wipe Equipment

Downloads:
 - [Datasheet](#)
 - [3D-Model](#)
 - [Usermanual](#)
 - [CAD-files \(DXF\)](#)
 - [EU Dec. of Conformity](#)

Pictures:

RoughCam[®] IPP1280

The RoughCam IPP1280 is a thermal network camera for use in industrial areas – **offering all advantages of thermal detection.** The RoughCam IPP1280 is a modular Network-Camera. This means that it consists of two units: the ultra compact sensor unit (lens and image sensor) and the main unit (network, power and memory card slot).

Features.

- Extremely Robust
- Ultra-Compact and Lightweight Sensor Unit in Combination with a Main Unit
- Thermal Technology for Low False Alarm Rate
- Single-Cable-Solution (PoE)
- Protection Level of IP68/IP66 (IEC 60529)
- Resolution thermal: 208x156

Extremely Robust IP-Camera

During the RoughCam IPP1280's development stage the focus was clearly laid on security aspects as well as mechanical precision and high-quality stainless steels. In addition, the modular design of the housing components prior to the camera's development allows a free combination of the individual housing components such as different flanges in combination with the housing body - without any limitations regarding explosion protection.

Various Applications

Thermal cameras can be used for various applications, completely independant from lightning conditions. In security services a thermal camera can optimally complete a visual camera.

If you wish additional technical information, please contact us at: support@samcon.eu

11 Certificates and further documentation

Certificates and further documentation are available in the download area at the product website:

<https://www.samcon.eu/en/products/network/excam-ipp1280>

12 Notes



SAMCON

Schillerstrasse 17, 35102 Lohra-Altenvers,
Germany

www.samcon.eu, info@samcon.eu

Phone: +49 6426 9231-0, fax: - 31

